

Unification of Classical and Quantum Theory Based on a Combination of Special Relativity and Sampling Theory

Norman Graves

8/Jan/2024

Abstract

The assumption that angular momentum is quantized underpins all of quantum theory. The assumption is at best questionable and most likely false since it violates the tenets of the scientific method.

A new model is proposed for the hydrogen atom which does not rely on this assumption and is based instead on a combination of a sampling process and special relativity. It is postulated that certain orbital velocity terms are themselves affected by relativity. This leads to a planetary model for the atom in which the electron orbits at near light speed and at a constant radius independent of energy level, thus obviating the need for changes of radius with energy level and the attendant changes in potential energy.

The model provides explanations for many of the incomprehensible phenomena associated with current theories. The dynamics involved are recognizably those of Newton and Einstein. It provides a simple mechanical explanation for the discrete energy levels of the atom, why synchrotron radiation does not occur, the nature of the fine structure constant and of zero point energy and the reason why Planck's constant is a constant. It does so under a single set of physical laws and so effectively unites classical and quantum mechanics.

Introduction

Hydrogen

First named by Antoine Lavoisier (1743 – 1794), hydrogen is the most abundant of all the atoms in the universe; it is the very stuff that stars are made of. It is estimated that hydrogen accounts for over 90% of all the atoms in the universe, comprising 75% of all the mass in the universe. Hydrogen is significant in other ways too. Hydrogen forms the basis of all other types of atom in the universe. It is structurally the simplest of all the atoms, consisting of a single proton acting as a nucleus and orbited by a single electron. All other atoms have a so called *hydrogenic* form where they are stripped of all but one orbiting electron. A comprehensive and detailed understanding of the workings of the hydrogen atom is therefore an essential step to an understanding of all other, more complicated, atoms.

Background

In 1900 at the age of 42 Max Planck (1858-1947) was Professor of Physics at the University of Berlin. Germany had been united since 1870 and was trying to establish its position as a major industrial power and beginning to flex its industrial muscles. One of the emerging technologies at the time was that of the incandescent electric light and the major German electrical companies, anxious to establish a world lead, commissioned Planck to investigate how they might maximise the efficiency of their incandescent light bulbs. The problem to which Planck turned his attention was to understand the relationship between the frequency at which a hot black body¹ radiated energy and its temperature.

All materials emit radiation when they are heated. At higher temperatures this is seen as first a dull red glow which gets brighter as the object gets hotter, passing first through red heat then white and finally blue. Interestingly the colour or frequency of the radiation is independent of the material involved so for example, iron gets red hot at exactly the same temperature as ceramic or indeed as any other material.

A physical law relating the temperature to the colour had been proposed in 1893 by the German physicist Wilhelm Wien (1864 – 1928) which worked well for higher frequencies but which failed at lower ones. A few years later another attempt was made in the form of the Rayleigh-Jeans law, first proposed in 1900 and later modified in 1905, while this worked at lower temperatures, it failed at higher ones. Planck himself had published what is referred to as the Planck-Wien law in 1899, but this too failed to match the experimental evidence.

Finally in December 1900, Planck presented a paper to the German Physics Society (Deutsche Physikalische Gesellschaft) in which he made the assumption that energy could only be released in discrete multiples of some elementary unit. The size of this unit of energy or quantum was proportional to the frequency and related by what is now known as Planck's constant. Light it would appear could only exist in discrete lumps or quanta the energy of which was proportional to their frequency. The new model fitted the data perfectly at both low and high temperatures.

Mathematically the energy in each such quantum is proportional to the frequency and the constant of proportionality is Planck's constant. So the energy of an individual quantum is given by the equation:

$$E = hF \quad \text{Equation 1}$$

Where E represents the energy of the quantum of radiation, F the frequency and h is the constant of proportionality, now known as Planck's constant.

¹ The term *black body* is used to describe a theoretically ideal emitter of energy.

Energy and frequency have different units or dimensions, which means that Planck's constant must itself have units or dimension. The units of Planck's constant are the product of a length, a velocity and a mass and match those of angular momentum. Planck's constant can have different values depending on the units being used. In SI units the value of Planck's constant is $6.62606896 \times 10^{-34} \text{ m}^2\text{kg/s}$ or **J s**. However it is often represented as what is known as the Reduced Planck's constant or Dirac Constant, which is simply this value divided by 2π . It has the value $1.054571628 \times 10^{-34} \text{ m}^2\text{kg/s}$ or **J s** and is given the symbol \hbar . The use of the reduced Planck's constant, \hbar , is consistent with representing the frequency as an angular frequency in radians per second rather than Hz or cycles per second. In this form Planck's equation can be written as:

$$E = \hbar\omega \qquad \text{Equation 2}$$

If it was Planck who introduced the idea, it was Albert Einstein (1879-1955) who was responsible for establishing the quantum as an integral part of modern physics. 1905 was a seminal year for Einstein and for physics. The first of the three landmark papers concerned the photoelectric effect and was published in March 1905. Einstein's second paper, published in May 1905, concerned the motion of tiny particles in suspension in a fluid; its English title is "*On the Motion Required by the Molecular Kinetic Theory of Heat of Small Particles Suspended in a Stationary Liquid*". This phenomenon had been observed some time before when grains of pollen are in suspension in water. It was documented in 1828 by the Scottish botanist Robert Brown (1773-1858) and hence was given the name Brownian motion. Einstein's third paper was submitted in June 1905 was entitled "*Zur Elektrodynamik bewegter Körper*" ("*On the Electrodynamics of Moving Bodies*"), and introduced the idea of what was later called Special Relativity. A later supplement added the now famous equation $E=mc^2$.

Atoms

By now it was becoming evident that significant aspects of the structure of matters were quantised. Planck had shown that energy came in discrete quanta, Einstein had shown that light too was quantized, it was clear that electricity was carried in discrete packets called electrons and Einstein had confirmed what many suspected, that matter was itself discrete and made up of atoms. It was also evident from work on ionisation and with the discovery of the electron, that atoms were not entirely indivisible. In the early part of the 20th century physicists began to turn their attention to the atom and to work on gaining an understanding of its structure.

J J Thomson (1856-1940) had put forward his idea of the "plum pudding" model of the atom, but this was just wild speculation. There were several other such dead ends; models that turned out not to be viable. Meanwhile Ernest Rutherford (1871-1937) began using radiation to probe the structure of the atom. In Canada Rutherford had noticed that Alpha particles were sometimes scattered as they passed through a thin sheet of mica. Rutherford, now back in Manchester, and assisted by Hans Geiger (1882-1945), started a series of experiments to examine this scattering in more detail. He used thin sheets of gold foil, bombarding them with Alpha particles and detecting the particles as they were scattered by the gold. Rutherford found that, as with the mica, while most Alpha particles passed straight through, a small proportion of the Alpha particles were deflected.

A young undergraduate, Ernest Marsden (1889-1970), joined the team and was given the job of investigating the extent to which the Alpha particles were deflected. Much to their surprise, they found that particles were sometimes deflected by very large angles, and indeed that some were reflected back directly towards the source. Rutherford described it as "... like firing a fifteen inch shell at a piece of tissue paper and it came back and hit you". He spent the next 18 months trying to understand what was happening.

Rutherford knew that Alpha particles carried a positive electric charge and he also knew that this would cause them to be deflected as they passed close to charged particles within the gold atom. He knew that some of these were negatively charged electrons, which were relatively light and would have very little influence on the much heavier alpha particles. But he also knew that the atom was

electrically neutral and therefore had to contain something which was positively charged to balance out the negative charge of the electrons now known to form a part of the atom. He reasoned that the behaviour of the alpha particles could be explained if all of the positive charge in the atom was concentrated at a single point at the centre of the atom. He called this point the nucleus. In Rutherford's model the nucleus was positively charged and contained most of the mass of the atom, the negatively charged electrons spread around at a distance, resembling a mini solar system.

Rutherford's planetary model of the atom still presented some difficulties. An atom with positive charge concentrated at the centre and stationary electrons disposed around it would be unstable. The negatively charged electrons would be attracted inexorably towards the positively charged nucleus. If on the other hand the electrons were in orbit around the nucleus the centrifugal force could balance the electrical force, however in order to complete their orbits the electrons would be undergoing a continuous acceleration towards the central nucleus, and when an electron is accelerated it radiates energy. This so called "synchrotron radiation" would sap the orbiting electron of its energy causing it to spiral in towards the nucleus. Despite these evident complications Rutherford chose to publish his results in 1911.

Coincidentally in the process of refining their measurements, Rutherford, Geiger and Marsden discovered the relationship between atomic weight and the number of orbiting electrons. Except in the case of hydrogen which has one orbiting electron and unit atomic weight, all other atoms had an atomic mass of double the number of electrons. This in itself was an important step in understanding the composition of atoms.

Rutherford's experiments bombarding gold foil with alpha particles showed that the atomic nucleus contained centres of positive charge. The idea eventually emerged that these were themselves particles and were given the name protons. It was also evident that protons on their own did not account for all of the mass of the nucleus and that there must be other particles involved. In 1920 Rutherford proposed what he called his *neutral doublet*, a particle with roughly the same mass as the proton but electrically neutral.

In 1928 the German physicist Walter Boethe (1891-1957) and his student Herbert Becker (1887-1955) created an experiment in which they bombarded beryllium with alpha particles and found that it gave off a very penetrating, electrically neutral radiation. At first they believed this to be high energy gamma radiation. In 1932 Irene Joliot-Curie (1897-1956), one of Madam Curie's daughters and her husband Frederic Joliot-Curie (1900-1958), decided to investigate Boethe's radiation. They bombarded a paraffin target with Boethe's radiation and found that it caused protons to be emitted. It was unlikely that this could be caused by gamma radiation, which lacks mass and would have insufficient momentum to dislodge protons.

James Chadwick (1891-1974), who was working for Rutherford in Manchester at the time, reported these results to Rutherford. He set about re-creating the experiment, but went much further, bombarding other targets including helium and nitrogen. By comparing the recoil energies of the protons that were being emitted from the targets, Chadwick was able to calculate that the beryllium emissions contained a neutral particle with approximately the same mass as the proton. In 1932 James Chadwick published his results in *Nature* in a letter entitled "*Possible Existence of a Neutron*". In 1935 James Chadwick received the Nobel Prize for his discovery.

Atomic Spectra

In the early 1800s the English chemist William Hyde Wollaston (1766-1828) and independently the German physicist Joseph von Fraunhofer (1787-1826) discovered that the spectrum of the sun contained a series of dark lines. Fraunhofer mapped the frequencies of these lines which are now named after him.

It was subsequently discovered by Robert Bunsen (1811-1899) and Gustav Kirchhoff (1824-1887) that each chemical element can be associated with a set of these spectral lines. The lines are caused by absorption of light by the atoms of the element at very specific frequencies. The presence and frequencies of these lines is a characteristic of the type of atom, rather like a fingerprint or a barcode.

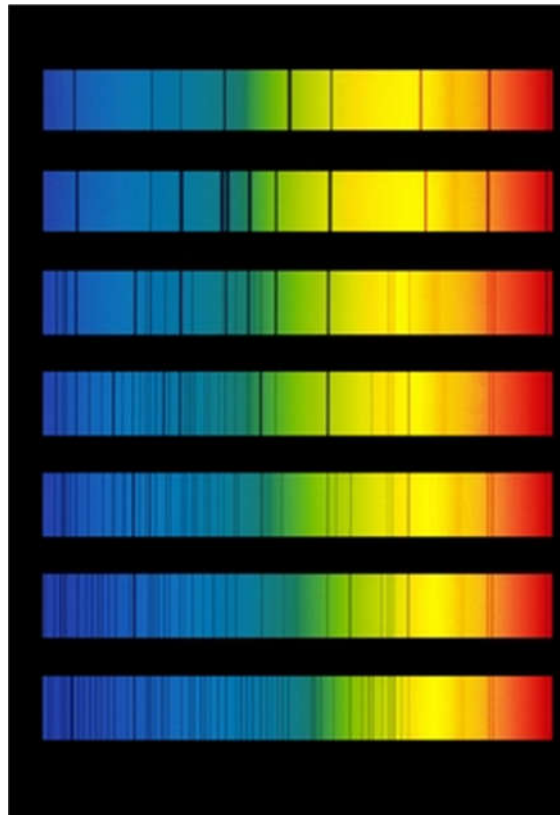

Figure 1 Absorption Spectra

A similar set of lines exists, and at the same frequencies, at which an atom emits light. It appeared that under certain circumstances atoms could absorb energy, but only at very specific frequencies, while under slightly different circumstances those same atoms would emit energy at those exact same frequencies.

Joseph Jakob Balmer (1825-1898) was a Swiss mathematician and numerologist who, after his studies in Germany, took up a post teaching mathematics at a girls' school in Basel. A colleague in Basel suggested that he take a look at the spectral lines of hydrogen to see if he could find a mathematical relationship between them. Eventually Balmer did find a common factor ($h = 3.6456 \cdot 10^{-7}$ - h here is not to be confused with Planck's constant) which led him to a formula linking the lines to one another.

$$\lambda = \frac{hm^2}{m^2 - 4} \quad \text{Equation 3}$$

Where m is an integer with values of 3 or higher

Balmer originally matched his formula for $m = 3,4,5,6$ and based on this he predicted an absorption line for $m = 7$ which was subsequently found to match a new line that had been discovered by Ångström.

Balmer's formula was later shown to be a special case of a more general result which was formulated in 1888 by the Swedish physicist Johannes Rydberg (1854-1937).

$$\frac{1}{\lambda} = R_H \left(\frac{1}{n_1^2} - \frac{1}{n_2^2} \right) \quad \text{Equation 4}$$

Where λ is the wavelength of the spectral line
 R_H is called the Rydberg constant for hydrogen
 n_1 and n_2 are integers and $n_1 > n_2$

By setting n_1 to 1 and allowing n_2 to take on values of 2, 3, 4 ... ∞ the lines take in a series of values known as the Lyman series. Balmer's series is obtained by setting $n_1=2$ and allowing n_2 to take on values of 3, 4, 5... Similarly for other values of n_1 series of spectral lines have been named according to the person who first discovered them and so:

n_1	n_2	Series
1	2 ... ∞	Lyman series
2	3 ... ∞	Balmer series
3	4 ... ∞	Paschen series
4	5 ... ∞	Brackett series
5	6 ... ∞	Pfund series
6	7 ... ∞	Humphreys series

Other series beyond these do exist, but they are not named.

By substituting different values for R , it was found that Rydberg's formula worked for all so called *hydrogenic* atoms. Such atoms consist of a nucleus with just one orbiting electron. These represent a special case, a class of problems where there are just two bodies involved, the atomic nucleus and the orbiting electron. Other atoms, for example where two electrons and a nucleus are involved, form a class of problem called a three body problem which have proved much more difficult to solve.

The Bohr Model

Niels Bohr (1885-1962) was born into a wealthy family in Copenhagen. It was in Copenhagen University where he undertook his doctoral thesis in Mathematics, receiving his PhD in 1911. Bohr won a Carlsberg scholarship to work under J J Thomson at Cambridge but Bohr and Thomson never quite hit it off, and so eight months into his one year scholarship, Bohr moved to Manchester to work under Rutherford's tutelage.

Bohr began his work at Manchester studying the position of atoms in the periodic table. His work led him to conclude that the position of an element in the periodic table was due to the number of positive charges in the nucleus, its atomic number, and not its atomic weight. He failed to persuade Rutherford to let him publish his results and so it was Fredrick Soddy (1877-1956) who got the credit for atomic number when he worked out a similar theory. Undaunted, Bohr moved on and began to work on the structure of the atom, having been inspired by a flaw that he had found in the work of another of Rutherford's accomplices, Charles Galton Darwin (1887-1962), grandson of Charles Darwin.

Bohr knew that Rutherford's planetary model of the atom was unstable. The electrons could not be stationary or they would collapse into the nucleus, they could not be in motion because they would spiral towards the nucleus as they radiated energy. Bohr chose to ignore the problem of stability and instead to concentrate on the dynamics of the atom. Only after he had solved this problem did he intend to look at the problem of stability.

Bohr was convinced that certain laws of physics broke down on the atomic scale and things were no longer smooth or continuous, so he "quantised" the orbits of the electron.

Taking hydrogen, the simplest of the atoms, as an example; it is now known that the nucleus of the hydrogen atom comprises a single proton. In order for the hydrogen atom to remain electrically neutral this proton must be balanced by a single electron which Bohr assumed was in orbit around the nuclear proton in line with Rutherford's model of the atom.

The electrical force between these two particles is given by the inverse square law for electric charge:

$$f_e = \frac{Kq^2}{d^2} \quad \text{Equation 5}$$

Where K is the electrostatic force constant, q is the charge on the electron and on the proton and d is the distance between them. For the case of an orbiting electron the distance is the orbital radius which can be written as r .

Bohr simply assumed that the electron orbit was circular and balanced the electrostatic force with the centrifugal force:

$$\frac{Kq^2}{r^2} = \frac{mv^2}{r} \quad \text{Equation 6}$$

Bohr found the inspiration for his next assumption in the work of a former colleague at Cambridge, John W Nicholson (1881-1955). Nicholson had been working on his own model of the atom and in doing so had made an important assumption.

An object moving in a straight line has a propensity to continue to do so. This propensity is termed the *momentum* of the object and is calculated as the product of its mass and its velocity. For an object that is rotating or in orbit there is a similar quantity called its *angular momentum* and for a point object or a particle in a circular orbit the angular momentum is given by the product of its mass, its velocity and its orbital radius.

What Nicholson had understood was that Planck's constant, the factor relating the quantisation of energy to its frequency, has the units of angular momentum. He reasoned therefore that the angular momentum of the orbiting electron was equal to Planck's constant. But he went one step further and assumed that this was just one value for the angular momentum, and that it could only take on values which were each integer multiples of Planck's constant.

From the classical equation

$$l = \hbar = mvr \quad \text{Equation 7}$$

Nicholson developed the modified version

$$l = n\hbar = nmvr \quad \text{Equation 8}$$

Where \hbar is Planck's constant, m is the mass of the electron, v is the velocity of the electron and n is an integer with values 1, 2, 3, 4, 5

Bohr now had two equations with two unknowns, r and v . He could solve these to calculate the orbital radius and the velocity of the orbiting electron for each of the different energy levels, n .

For $n = 1$ which is referred to as the ground state, base state or lowest energy state.

$$kq^2 = mrv^2 = \hbar v \quad \text{Equation 9}$$

$$v = \frac{Kq^2}{\hbar} = 2187803.961 \text{ m/s} \quad \text{Equation 10}$$

This is frequently referred to as the Bohr Velocity and is just under 1% of the velocity of light.

And

$$r_n = \frac{\hbar^2}{mKq^2} = 5.29149 * 10^{-11} \text{ m} \quad \text{Equation 11}$$

Commonly referred to as the Bohr Radius

And for the general case of the n^{th} energy state:

$$v_n = \frac{Kq^2}{n\hbar} \quad \text{Equation 12}$$

In the Bohr model the velocity of the orbiting electron varies as the inverse of the energy level. In other words, somewhat paradoxically, the velocity gets less as the energy level increases.

And

$$r_n = \frac{n^2 \hbar^2}{mKq^2} \quad \text{Equation 13}$$

The radius for each energy state increases as the square of n over the Bohr Radius meaning that the atom gets bigger as the energy level increases.

At first sight it would appear that the energy of the electron in the Bohr model gets less with increasing energy state and the kinetic energy certainly does. However this is not the case, since in moving from a low energy state the electron loses kinetic energy, but gains potential energy. The exact amount is given by the Virial theorem and is equal to double the kinetic energy in each state.

Bohr's model appeared to accurately describe the behaviour of the hydrogen atom but in doing so Bohr had to introduce Nicholson's idea that the angular momentum of the orbiting electron could only take on these very specific values which were integer multiples of Planck's constant. Bohr failed to explain just why this should be the case, and there was another problem which defied explanation. To satisfy the requirements of the Bohr model, when the energy of the atom changes from one energy state to another the electron has to jump between two energy states, in effect jumping between two orbits of different radii. The electron has to make the transition from one orbit to another instantaneously and without ever occupy any position in between the two orbits. Such transitions between orbits represent discontinuities of position and appeared to defy rational explanation. They were given the name 'Quantum Leap' and the term has since come to mean any seemingly improbable change of position.

When a charged particle is subject to acceleration it normally emits a type of radiation called *synchrotron radiation*. The electron in the Bohr atom is subject to centripetal acceleration and so should emit such radiation. If the Bohr atom were to emit such synchrotron radiation the energy of the electron would be sapped resulting in the orbit decaying over time. Bohr had chosen to ignore the question of stability and that of synchrotron radiation, preferring to come back to this at a later date. In fact he never did so and so these questions remain open to this day. Bohr also ignored the effects of relativity on the mass of the electron, which for hydrogen is very small, but the Bohr model works for

all so called hydrogenic atoms, that is; atoms which are ionised such that they have a single orbiting electron. For more massive atoms, the effects of relativity become increasingly significant.

The Fine Structure Constant

The Fine Structure Constant was first described and introduced into physics in 1916 by Sommerfeld. It was while he was looking into the absorption spectra of hydrogen and noticed that the orbital frequencies of the Bohr model were related to the corresponding frequencies of emitted or absorbed radiation. They matched perfectly if he introduced a correction factor. That correction factor is now known as the Sommerfeld Fine Structure Constant and is again found as the ratio between the orbital velocity of the electron and the speed of light in the base energy state of the Bohr model for the hydrogen atom. Numerically it has a value of 0.007297352, but is often referred to by its reciprocal, which is 137.036.

Since 1916 it has been found to exist elsewhere in numerous other areas, and especially in Quantum Electro Dynamics (QED), but no-one knows exactly what it signifies or why it should have this particular value. Various attempts have been made to explain it in terms of numerology or to relate it to other physical constants without success

Wave Particle Duality

Bohr's model appeared to describe the energy levels of the atom, but something was missing. His model failed to explain why this quantisation should occur. Next to enter onto the scene was a French aristocrat called Louis de Broglie.

Louis de Broglie (1892 – 1987) was born into an aristocratic French family in August 1892 in Dieppe. Louis first studied history, but developed an interest in physics as a result of working with his older brother Maurice. Maurice had been a naval officer where he worked on early radio systems for ship to ship and ship to shore communication. In 1904 he left the navy to study physics. Maurice pursued his interest in physics by setting up a private laboratory to study X-Rays. He attended the first Solvay conference, held in Brussels in 1911, in the capacity of scientific secretary. It was after reading the proceedings of this conference, largely written by his brother Maurice, that Louis decided to abandon his studies of history and to focus instead on physics. After graduating in 1913, Louis was called up for military service. Events in Europe meant that before his military service was completed, France was at war and Louis was to remain in the army for another 4 years. His time spent in the army was not altogether wasted; he spent most of his military service as a radio engineer working at the base of the Eiffel tower in Paris.

In 1905 Einstein had shown that the hitherto wavelike nature of light concealed an underlying particle-like behaviour. In 1923 de Broglie was struck with the idea that maybe this situation could be reversed, that perhaps what had hitherto been thought of as a particle could be described in terms of a wave. De Broglie discovered that if he assigned a wavelength and a frequency to an electron he could explain the location of the atoms in the Bohr model of the atom. He found that the orbiting electrons could only occupy orbits which contained a whole number of such wavelengths. De Broglie published his theory in 1924.

De Broglie's idea hinges around the notion of standing waves. A standing wave occurs for example in a taut string, anchored at both ends, that is plucked. The fundamental frequency occurs when the whole length of the string vibrates. Other modes of vibration are also possible, for example where the centre of the string remains stationary and the two halves of the string each vibrate at what is referred to as a second harmonic frequency. This can also happen at the third, fourth and other higher harmonics. Here then was a possible explanation as to why the electron orbits could only take on whole number multiples of a base value.

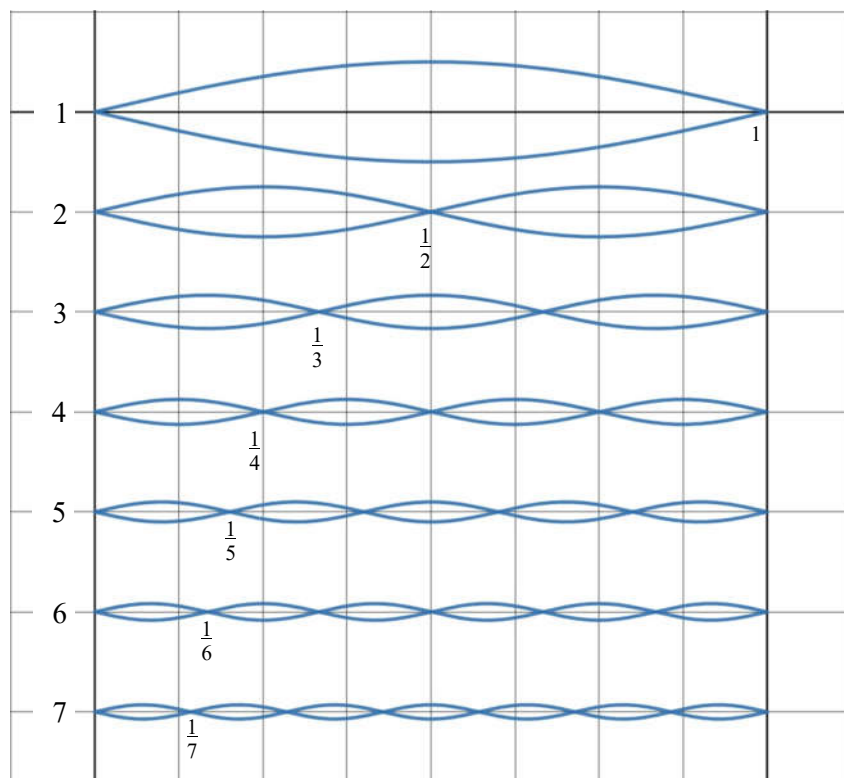

Figure 2 Standing Waves

In the base energy state the electron is oscillating at the fundamental frequency that is there is one whole cycle of the electron as a wave during one complete orbit. In the second energy state the electron is oscillating at exactly twice the frequency of the orbit of the electron, forming a standing wave where two wavelengths are required to describe one complete orbit. This carries on in the third and higher orbits.

In 1929 Louis de Broglie received the Nobel Prize for Physics.

The Heisenberg Uncertainty Principle

Werner Heisenberg (1901 – 1976) was a German physicist who studied physics and mathematics in Munich. He studied under Arnold Sommerfeld alongside Wolfgang Pauli (1900-1958), but it was when he first met Niels Bohr that his interest in quantum physics and his career took off.

In 1926 he was working on a way to explain the relative intensities of the emission and absorption lines of hydrogen when he stumbled onto an idea which was to have far greater importance. He chose to represent the frequencies and intensities of the various absorption and emission lines as a table of values. It was while trying to manipulate this table that he discovered that the normal rules of multiplication did not seem to apply. What Heisenberg has unwittingly discovered was matrix manipulation. Matrix manipulation is now commonplace in mathematics and was known in mathematical circles in the 1920's, but Heisenberg was a physicist and not a mathematician, so he struggled for some time to come to terms with his discovery. Multiplication of matrices is not commutative, that is $[A][B] \neq [B][A]$, the result of multiplying two matrices together is different depending upon the order in which the multiplication is written.

When Heisenberg applied this to the momentum and position of a particle he found the relationship:

$$[X][P] - [P][X] = \hbar[I] \quad \text{Equation 14}$$

Where $[I]$ is known as the identity matrix and is the equivalent of unity in matrix multiplication, so $\hbar[I]$ is the equivalent of a constant in matrix multiplication.

Heisenberg realized that the non-commutative nature of this matrix multiplication implied that it was not possible to know both the position and the momentum (velocity) of a particle to an arbitrary degree of accuracy. There was an uncertainty inherent in the system which was related through the constant term to Planck's constant, which appears in the right hand side of the equation. This subsequently became known as the Heisenberg Uncertainty Principle.

Heisenberg first sought to explain the uncertainty principle by looking at the way in which things are measured. To determine the momentum of a small particle such as an electron it is necessary to measure both its mass and its velocity. All electrons have the same rest mass, so to measure the momentum it is sufficient to measure just the velocity. Velocity can be determined by measuring position at two points separated by a small interval of time. On the scale of the electron however, the only tools available to measure the position are other sub atomic particles such as electrons or photons, which are of comparable size and have comparable energies.

The situation can be likened to that of trying to measure the position and velocity of a golf ball when the only tools available to make the measurements are other golf balls. By firing a stream of golf balls at the subject golf ball, eventually one will hit. The position of the subject golf ball can then be determined by detecting the fact that one of the incident balls scored a hit and deviated from its trajectory. Unfortunately the very fact that there was such a collision means that the velocity of the subject golf ball has changed. Furthermore the extent of such a change is indeterminate and so it is now impossible to perform a meaningful second measurement to discover the velocity of the subject golf ball.

The position of an electron can be measured by bombarding it with photons. The accuracy of such a measurement is proportional to the wavelength of the incident light. The lower the energy of the incident light, the less the disturbance when it interacts with the subject electron, but at the same time the accuracy of the measurement is reduced. Using light of a longer wavelength and hence a lower frequency means less accuracy when measuring position. Using light of a shorter wavelength and higher frequency while it improves the accuracy of the measurement of position has a secondary effect in that it presents more of a disturbance to the electron which is the subject of the measurement, making the measurement of the electron's velocity less accurate.

If the incident light has a wavelength of λ then the photons each carry momentum of h/λ . This means that the higher the frequency of the incident light the greater its momentum and the more the effect it has on the momentum and position of the electron which is the subject of the measurement. If Δp and Δx are the standard deviations in the measurement of momentum and position respectively then it can be shown that:

$$\Delta p \Delta x \geq \frac{\hbar}{2} \quad \text{Equation 15}$$

In this case position and momentum form what is termed a conjugate pair of measurements. The uncertainty principle applies to any such conjugate pair. Another example of such a pairing is time and energy. In this case the uncertainty principle can be restated as:

$$\Delta e \Delta t \geq \frac{\hbar}{2} \quad \text{Equation 16}$$

The Schrödinger Wave Equation

Independently of Heisenberg the Austrian physicist Erwin Schrödinger (1887 – 1961) took a different approach but arrived at much the same conclusion. Schrödinger had been made aware of de Broglie's

ideas that particles could be regarded as waves as a result of correspondence with Einstein. He was asked to give a presentation on de Broglie's waves by Peter Debye (1884-1966). When Schrödinger gave his talk, Debye dismissed it as being childish because it did not contain an equation to describe the said waves. Schrödinger took up the challenge and set about discovering a wave equation to describe de Broglie's matter waves. The resulting equation is a second order partial differential equation involving both distance and time. The Schrödinger wave equation only has meaningful solutions for certain discrete values of the total system energy. In the case of the hydrogen atom these are found to correspond to the discrete energy levels of the atom.

Schrödinger's wave amplitudes have no direct physical interpretation they are the self-same waves as proposed by de Broglie. Max Born (1882 – 1970) went on to show that the square of the amplitude represented the probability distribution of the position of the particle. In the case of the hydrogen atom the peaks in these functions for the various energy levels correspond to the orbital radii predicted by the Bohr model.

Just as with the Bohr model, the equation can only be solved analytically for hydrogen itself and for other so called *hydrogenic* atoms, which are atoms which are ionized so as to have a single orbiting electron.

Eventually Schrödinger, Carl Eckhart (1902-1973) and Paul Dirac (1902-1984) each independently showed that Heisenberg's matrix mechanics and Schrödinger's wave equations were mathematically equivalent and were in fact just different manifestations of the same phenomenon.

Schrödinger believed that he had eliminated Bohr's awkward quantum leaps. Energy changes in the Schrödinger model were represented by changes in the probability that the electron occupied one particular orbit or another in a way that is analogous to the way in which the frequency of a violin changes from one note to another. But this is where quantum theory really started to take on a surreal quality.

The Copenhagen Interpretation

Bohr thought that Heisenberg's explanation of uncertainty was flawed. Heisenberg's original idea, that uncertainty was a practical problem of measurement, did not sit with Bohr's idea that the laws of physics were different on the atomic scale. Bohr took a holistic view in which the observer and the observed could not be separated and argued that light, for example, exists as both a wave and as a particle at the same time. It only manifests itself as one or the other form when it is measured or observed. It is at the point where an observer chooses how to measure the particle that its nature becomes fixed. Instead of being capable of description as either a wave or a particle, objects can be described in terms of a *wave function*. Bohr described the process of observation as the *collapsing* of the wave function into either a particle or into a wave.

According to Bohr the original wave function contains all of the possibilities within it. It manifests itself as one form or another, not because it changes in nature from one form to another, but because the observer is looking for that particular form.

In essence what Bohr was arguing was that Heisenberg's uncertainty was an intrinsic property of the individual particles themselves, not a phenomenon associated with their measurement. Schrödinger's probabilities were not a property associated with a population of particles in the way that probability normally occurs, but were somehow integral to the very nature of the individual particle.

This idea that uncertainty is an integral property of matter is central to modern quantum theory. It implied that reality could not be separated from the process of observation, in other words that reality was somehow subjective. The idea was to result in a schism in the world of nuclear physics between those who accepted such a subjective reality and those who did not. The principle protagonists in this

debate were Einstein and Bohr, with Bohr an advocate of subjective reality and Einstein an advocate of an alternative objective reality.

The idea of a wave function which collapses into a particle presents us with a conundrum. When it is observed the electron supposedly is transformed from a nebulous cloud of something into a point particle in the classical sense. The so called Measurement Problem is all about how and when this transformation takes place, but there is also the problem of how and when the electron reverts from being a particle to back to being a wave function.

Schrödinger's Cat

Scientists were understandably sceptical about Bohr's ideas and about the Copenhagen interpretation. Einstein in particular was never reconciled to it and spent the rest of his life trying to disprove it.

Erwin Schrödinger sought to explain just how ridiculous the Copenhagen interpretation was by using an example based on everyday objects rather than objects on an atomic scale. Schrödinger imagined a cat sealed in a box. Also in the box was a device, inaccessible to the cat, which contains a vial of poisonous gas and a triggering mechanism. The trigger contains a small amount of radioactive material, sufficient that there is a 50% probability that the device will trigger in a one hour period. Thus the outcome of the experiment is that the cat stands a 50:50 chance of being killed during the one hour it is locked inside the box.

Schrödinger argued that, following the logic of the Copenhagen interpretation, that during its one hour spent in the box the cat exists in a fuzzy state of being neither dead nor alive while simultaneously being both dead and alive. It is only when the box is opened that the fate of the cat becomes evident, to coin the terminology of the Copenhagen interpretation its status *collapses* when the box is opened revealing the cat to be either alive or dead. Even more radical is the idea that the history of the cat over the previous hour also *collapses* when the box is opened to either be that of a living cat or that of a cat that died during its hour long ordeal.

Although Schrödinger is now lauded as one of the architects of quantum theory, he never quite came to terms with it or its implications, siding with Einstein in the ensuing debate.

Problems with Quantum Theory

Anselm of Aosta (1033 – 1109) was a monk of the Benedictine order in the 11th Century. He rose through the ranks of the church to become Archbishop of Canterbury and was eventually canonized. He is remembered for establishing Canterbury as the principal seat of the English church.

Anselm was of the opinion that belief in God was more than just an article of faith but was also rational. He sought to show this by proving the existence of God using logic. His logic was convoluted, but the essence of his argument was that if we postulate that God exists then we can, through a series of logical steps, prove that God exists. Such a circular argument is of course invalid. It is a self-fulfilling prophecy and so it is simply not the case that by assuming something to be true you can prove that therefore it must be true. The upshot is that belief in God remains an article of faith. What Anselm's failed proof illustrates is that it is not possible to depend on the truth of an assumption in order to prove the assumption to be true.

Anselm's 'proof' or rather its failure to prove the existence of God can provide us with some important clues as to how we might go about validating Nicholson's assumption and so validating quantum theory, or disproving it and so seek an alternative theory.

The fact that quantum theory rests on the assumption that angular momentum is quantized means that it is not possible to validate quantum theory and prove that angular momentum is quantized by

consideration of anything from within the quantum realm, since everything that comes after is dependent on the said assumption. This means that there is no way to obtain such a proof by relying on Bohr's model of the atom, on de Broglie's wave particle duality or Schrödinger's wave equation or anything that depends on any of these.

If we cannot prove the validity of the assumption from the perspective of quantum theory then the only alternative is to base such a proof on classical mechanics. As we have seen, Newtonian mechanics is insufficient to explain the fact that the atom has an infinite number of energy states. In order to prove quantum theory, or indeed develop a valid alternative theory, it is necessary that we somehow modify Newtonian mechanics in such a way as to present us with an infinite number of energy levels and in such a way that the differences between energy levels matches those of the empirically derived Rydberg formula. In simple terms the equations of motion of the orbiting electron must somehow incorporate an integer multiplier which represents the energy level of the atom.

This is exactly what Niels Bohr tried to do when he derived his eponymous model for the hydrogen atom. He modified the equation for angular momentum by adding an integer multiplier. He argued that the model presented by Newtonian mechanics was incorrect because it did not take account of the idea that angular momentum was quantized into units of Planck's constant. By modifying classical Newtonian mechanics in this way Bohr was able to derive a model which matched the energy levels of the Rydberg formula. In effect Bohr took the simplest possible approach and attached an integer multiplier to the angular momentum term, transforming Equation 7 into Equation 8.

Bohr's approach of associating an integer multiplier, 'n,' with Planck's constant can at best be described as naïve or simplistic. Bohr appears to have looked at Newton's equations of motion for a planetary atom and asked himself which of the six variables the number 'n' could be bound to. If we attach it to the radius we don't get the right answers, if we attach it to the mass term then n would cancel between the two equations, if we associated it with charge or velocity it would seem that there is the problem of the exponent which is two for both variables and would mean some sort of square root in the solution and so would not deliver the right result which just leaves K and \hbar . We can contrive for each of these to give us results which match the energy levels of the atom, but Bohr chose \hbar .

Reductio ad Absurdum

While it is not possible to prove that a postulate is true based on the truth of the assumption which underlies it, the obverse is not the case. It is possible to disprove postulate by first assuming that it is true and then showing that this leads to a contradiction, a paradox or an absurdity. Such proofs are referred to as *Reductio ad Absurdum* and are commonplace throughout mathematics and date back to ancient times. A good example is Euclid's proof that the square root of two is irrational. Euclid first postulates that the square root of two is rational and then shows that this leads to a contradiction and hence that it cannot be true. Indeed the so called 'scientific method' is itself based on the underlying logic of *reductio ad absurdum*. This requires that we first put forward an assumption or postulate and based on this develop a model. The model is then tested against experimental or empirical data and if it fails, then not only the model, but also the postulate underpinning the model is deemed to be incorrect. In this case the absurdity is the failure of the experiment used to test the model, but otherwise the logic is essentially the same.

The assumption that angular momentum is quantized is just such a case where we can apply the logic of *reductio ad absurdum*. Using this assumption we can derive Bohr's model for the hydrogen atom, however the model leads to the "quantum leap" which is clearly a physical impossibility. It was recognized that this was sufficient to render the Bohr model invalid, but what was not recognized at the time, nor indeed since, is that it means that not only the model, but the assumption that lies behind it, must also be invalid. That is; angular momentum cannot be quantized, at least not in the way that Nicholson and Bohr describe.

To get around this slight inconvenience, it is frequently asserted that the Bohr model is obsolete and that our view of the world has moved on, that reality is not what it seems, that particles do not exist until they are observed etc. However it is a false premise to proceed along these lines when the underlying assumption has already been shown to be false. What all of these circumlocutions amount to is simply another way of trying to describe the quantum leap but without using the words “quantum” or “leap”. The electron, for example, is described as a wave function which “collapses” when it is observed to reveal the position or the velocity of the electron itself, which is now viewed as being in its particle form rather than its wave-like form. The process of collapsing is just another way of describing the instantaneous transformation of the electron into a particle which then exists at some point in space by denying that it existed as a particle prior to this transformation. In reality all such descriptions are simply euphemisms for the quantum leap.

The fact that the Bohr model leads to the absurdity of the quantum leap clearly demonstrates that the assumption that angular momentum is quantized is false. To then argue that it is correct to assume that angular momentum is quantized if we change to viewing the electron as a wave rather than as a particle is equally invalid. It is akin to telling Euclid that the square root of two is a rational number if we change the context in which we view it. It is logically inconsistent to accept that the quantum leap is a physical impossibility and to still assert that angular momentum is quantized. Once a postulate is shown to be invalid it remains irredeemably invalid whatever the context.

Waves and Particles

While Einstein had proposed that the photon, which had been regarded as a wave, could be regarded as a particle, de Broglie sought to suggest that the opposite; that what had hitherto been regarded as a particle could also be regarded as a wave. However de Broglie based his idea of a wave on the assumption that angular momentum is quantized.

When we look at an object in orbit, its wavelength can be regarded as the orbital circumference, its peak to peak amplitude is the orbital diameter and the orbital frequency is the reciprocal of the orbital period. If we know the orbital angular momentum of the object together with its linear momentum we can calculate the orbital radius by simply dividing orbital angular momentum by linear momentum. From this the wavelength is obtained simply by multiplying the result by 2π . However de Broglie's waves do not conform to this model. Instead de Broglie identifies a novel type of wave with a wavelength equal to Planck's constant divided by the linear momentum while at the same time asserting that the total angular momentum is an integer multiple of Planck's constant. The result is a foregone conclusion; that a whole number of de Broglie's waves will fit into the orbital circumference of Bohr's model for each and every energy state. De Broglie's waves have no physical interpretation. There is nothing physically waving at the frequency and with the wavelengths that they describe. They exist only as mathematical entities.

Although they have no physical interpretation, de Broglie's standing waves are frequently illustrated as shown in Figure 3 for $n=3$ and 4 respectively. This diagrammatic representation clearly shows the relationship between de Broglie's standing wave model and the Bohr model where the circular orbit around which de Broglie's waves are disposed is in fact the Bohr orbit for the corresponding energy level.

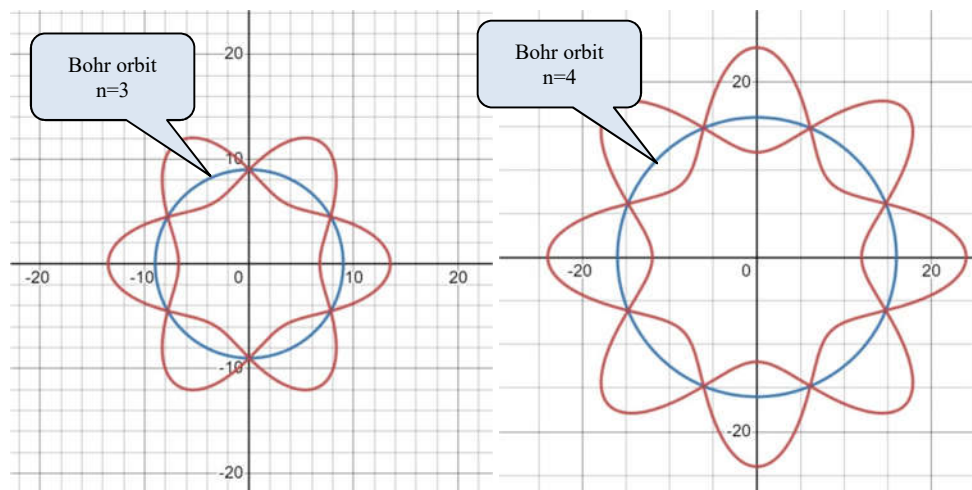

Figure 3 de Broglie's Standing Waves for $n=3$ and $n=4$

Broglie's results were hailed as providing a great insight into the workings of the atom, but in reality they don't. Rather than supersede the Bohr model, de Broglie's model augments it.

Nevertheless Bohr argued that this could address his problems with the quantum leap. Instead of moving from one orbit to another, the electron simply had to change the mode in which it vibrated from that of one harmonic frequency to that of a higher or lower harmonic frequency. However simply changing the mode of vibration is insufficient since the orbital path around which the waves travel must also change together with both kinetic and potential energy and that is a manifestation of the quantum leap.

In the Copenhagen interpretation the electron exists as either a wave or a particle while simultaneously existing as both a wave and a particle in what is referred to as 'the wave particle duality'. This 'wave particle duality' is said to exist **between** the electron being regarded as a wave and it being regarded as a particle and is to a large extent based on the ideas set forth in Louis de Broglie's PhD theses which was published in 1924.

As a consequence the conventional relationships between the particle like properties and the wavelike properties of the electron break down and so the wavelength can no longer be said to be the orbital velocity divided by the orbital period. The particulate form is the Bohr model of an electron in circular orbit but there is no circular motion which could act as a generating circle for the de Broglie's waves and so there is no concept of an orbital radius or orbital diameter related to the de Broglie waves.

It therefore becomes necessary to create a new set of physical laws which operate on this scale. And it is not just a new set of laws, but the very idea of what constitutes a material particle is called into question. It is said to exist in some sort of nebulous state as neither particle nor wave, but to exist as both at the same time. When it is observed, it undergoes some sort of metamorphosis, transforming into either a wave or a particle depending upon what the observer is looking for.

Despite having received the Nobel Prize in 1929 de Broglie had misgivings about his own idea and from around 1948 was to spend almost 40 years trying to establish a 'causal relationship' between his wave mechanics and classical mechanicsⁱ. He never managed to do so, developing instead what he called Pilot Wave Theory. Pilot wave theory does recognize that there are two types of wave associated with each stable state of the atomⁱⁱ. One is the de Broglie waves and the second is the wave associated with the corresponding state in the Bohr model.

In Pilot Wave Theory, particles are considered to have both a physical particle-like form and a "pilot wave." The pilot wave guides the motion of the particles determining their trajectories through space

and time. While Pilot Wave Theory provides an alternative to the Copenhagen interpretation it fails to provide the causal relationship that de Broglie was looking for.

Schrödinger's wave equation

Schrödinger was challenged to develop a wave equation to describe de Broglie's waves after giving a lecture on the subject. To do so he was forced to describe de Broglie's waves as travelling waves that travel around the Bohr orbit. His wave equation therefore had to be couched in terms of two variables, time and distance. He was further constrained by the need to account for changes in potential energy between the various energy states; a tacit acknowledgement of the quantum leap. This meant that the proposed solutions were complex, which, not surprisingly, took on real values when the wavelength of the de Broglie waves was an integer fraction of the Bohr orbital circumference. Once again the result is a foregone conclusion since the assumption that angular momentum is quantized is built in to the equations from the outset.

The argument that first Bohr, then de Broglie and finally Schrödinger had somehow validated quantum theory bears a striking resemblance to St Anselm's proof of the existence of God. First we postulate that angular momentum is quantized then through a series of circumlocutions we conclude that angular momentum is quantized.

Experimental Evidence

What we are left with as evidence for the validity of quantum theory is the results of experiments. It is argued that quantum theory produces results of extraordinary accuracy and is often cited as proof that it is correct but somehow incomplete; that what is necessary is just some little addendum which will make everything slot into place. Such a justification is however completely unfounded. There are many examples where theories which lasted for centuries were eventually discredited. A case in point concerns planetary motion. For something like two thousand years the most accurate model of the motion of the planets was based on epicycles, no other theory could match it for accuracy. Over time it got more and more complicated as minor perturbations were discovered and required the addition of yet more cycles. And then along came Kepler and Newton who showed that all of this complication was completely unnecessary and that the planets followed elliptical orbits based on the inverse square law. In fact the epicyclical model continued to be more accurate than Kepler's model until Einstein developed his theory of general relativity in so far as it was capable of modeling the perihelion of Mercury, which Kepler could not.

The seemingly accurate results of quantum mechanics cannot be considered as a means of validating the theory. The results from quantum mechanics may be extremely accurate, but this is not to say that these exact same results could not be obtained from another more rational model.

The specious assumption that angular momentum is quantized underpins not only the quantum leap but everything that is incomprehensible and wrong with quantum theory. That assumption is demonstrably false since it violates the very tenets of the scientific method. So it begs the question as to how we might proceed to modify or replace the theory with one which does not rely on the assumption that angular momentum is quantized. Clearly there is nothing within the domain of quantum theory which will solve the problem, since the theory depends on the aforementioned assumption. This means that we must look for a deficiency in classical mechanics which yields the necessary result. It is highly unlikely that there are two deficiencies in Newtonian mechanics and we already know that Newtonian mechanics fails to take into account the effects of relativity. A good starting point therefore is to look to see if it is our current understanding of relativity where the said deficiency lies.

The problem is fundamentally the same as that faced by Niels Bohr and that is how to introduce an integer multiplier into the Newtonian equations so as to be able to describe the various energy levels

of the atom. However rather than simply assert that such a multiplier is associated with this or that variable the solution has to be to find a mechanism that could cause some variable to take on discrete values in the context of the dynamics of the atom.

The Rydberg Formula and Series

The Rydberg formula describes the relationships between the various energy levels of the hydrogen atom. It is important to understand that Rydberg's formula is based on the results of experiment and observation. It does not seek to explain the spectral lines, rather it seeks to describe them and it is complete, that is it describes objectively all of the spectral lines for hydrogen. The formula deals only with the differences in energy between the various energy states. It has nothing to say about the absolute value of energy carried by the orbiting electron. The Rydberg formula forms a sort of gold standard against which any successful model for the hydrogen atom may be tested.

The Rydberg formula was given in Equation 4. In this form it uses the somewhat obscure wave number ($1/\lambda$). It can be expressed more usefully in terms of the energy emitted or absorbed when a transition takes place. This is achieved by multiplying both sides of Equation 4 first by c , the velocity of light and then by h , Planck's constant². Gathering terms and substituting the analytical value for R_H gives:

$$E_{n_1, n_2} = \frac{1}{2} m c^2 \alpha^2 \left(\frac{1}{n_1^2} - \frac{1}{n_2^2} \right) \quad \text{Equation 17}$$

Where m is the rest mass of the electron and α is the Sommerfeld Fine Structure Constant (Alpha)

The Rydberg formula tells us the amount of energy released when the electron orbiting the hydrogen nucleus makes a transition from the n_2^{th} energy state to the n_1^{th} energy state, or conversely the amount of energy absorbed if the transition is in the other direction. By letting $n_2 = \infty$ we obtain the energy associated with a transition to or from the maximum possible energy state of the electron and its energy in the n^{th} energy state, that is we obtain the *energy potential*³ of the atom in the n^{th} energy state.

Doing so leads to the Rydberg Series

$$E_\infty - E_n = \frac{1}{2} m c^2 \frac{\alpha^2}{n^2} \quad \text{Equation 18}$$

The Rydberg Series is particularly useful because it allows us to easily calculate the energy associated with any transition simply by taking the difference between two values in the series.

It is reasoned here that the electron orbiting the atomic nucleus must do so at the constant radius, that is to say at the same orbital radius for every energy state. Anything other than this would imply the existence of the physically impossible 'quantum leap', the ability to move from A to B without occupying anywhere in between. This in turn means that there can be no change in potential energy when the electron transitions from one energy state to another energy state. All changes in energy must therefore be kinetic in nature.

E_n is the energy potential of the n^{th} energy state and represents the difference between the energy of the electron in the n^{th} energy state and that in the most energetic energy state possible, the ∞ energy state or *energy ceiling* of the atom. Since nothing can ever travel faster than the speed of light, the energy ceiling is limited by the speed of light to be

² Note that this is the long form of Planck's constant

³ Note that energy potential is not the same as potential energy.

$$E_{\infty} = \frac{1}{2} mc^2 \quad \text{Equation 19}$$

And the energy of the electron in the n th energy state is

$$E_n = \frac{1}{2} m v_n^2 \quad \text{Equation 20}$$

Where v_n is the orbital velocity in the n^{th} energy state

It is the difference between the energy ceiling and the energy in the n^{th} energy state that is expressed in the Rydberg series, so by definition

$$\frac{1}{2} mc^2 \frac{\alpha^2}{n^2} = \frac{1}{2} mc^2 - \frac{1}{2} m v_n^2 \quad \text{Equation 21}$$

Equation 21 can be simplified to give

$$c^2 - v_n^2 = c^2 \frac{\alpha^2}{n^2} \quad \text{Equation 22}$$

And further simplified to give

$$\sqrt{\frac{c^2}{c^2 - v_n^2}} = \frac{n}{\alpha} \quad \text{Equation 23}$$

The term on the left hand side of Equation 23 will be recognized from as the Lorentz factor Gamma (γ) and hence

$$\gamma_n = \frac{n}{\alpha} \quad \text{Equation 24}$$

The variable of quantization is Gamma, the Lorentz factor. While Equation 24 tells us what is quantized and how it is quantized it does not tell us why it is quantized.

The Lorentz factor, Gamma, is not inherently quantized. There are many examples where Gamma is known to take on values which are not related to the fine structure constant in any way. This means is that there has to be something about the dynamics of the hydrogen atom which causes Gamma to only take on these discrete values.

There are some possible clues to be found in Equation 24. The presence of the Gamma term indicates that the mechanism involves special relativity in some way. The presence of the integer n is indicates that the solution also involves a sampling function.

Sampling

In the 1930's and 40's telecommunications engineers were concerned to increase the capacity of the telephone network without having to bury more cables. One of the ideas that surfaced was called Time Division Multiplexing. In this each of a number of incoming telephone lines is sampled by means of a switch, the resulting samples are sent over a trunk line and are decoded by a similar switch at the receiving end before being sent on their way. This allowed the trunk line to carry more telephone traffic without the expense of increasing the number of cables or individual lines. The question facing the engineers at the time was to determine the minimum frequency at which the incoming lines needed to be sampled in order that the telephone signal can be correctly reconstructed at the receiving end.

The solution to this problem was arrived at independently by a number of investigators, but is now largely credited to two engineers. The so called Nyquist-Shannon sampling theorem is named after Harry Nyquistⁱⁱⁱ (1889-1976) and Claude Shannon^{iv} (1916 – 2001) who were both working at Bell Labs at the time. The theorem states that in order to reproduce a signal with no loss of information then the sampling frequency must be at least twice the highest frequency of interest in the signal itself. The theorem forms the basis of modern information theory and its range of applications extends well beyond transmission of analog telephone calls, it underpins much of the digital revolution that has taken place in recent years.

What concerned Shannon and Nyquist was to sample a signal and then to be able to reproduce that signal at some remote location without any distortion, but a corollary to their work is to ask what happens if the frequency of interest extends beyond this Shannon limit? In this condition, sometimes called under sampling, there are frequency components in the sampled signal that extend beyond the Shannon limit and maybe even beyond the sampling frequency itself.

A simple example can be used to illustrate the phenomenon. Suppose there is a cannon on top of a hill, some distance away is an observer equipped with a stopwatch. The job of the observer is to calculate the distance from his current location to the cannon. Sound travels in air at roughly 340 m/s. So it is simply a matter of the observer looking for the flash as the cannon fires and timing the interval until he hears the bang. Multiplying the result by 340 will give the distance to the cannon in meters, let's call this distance D.

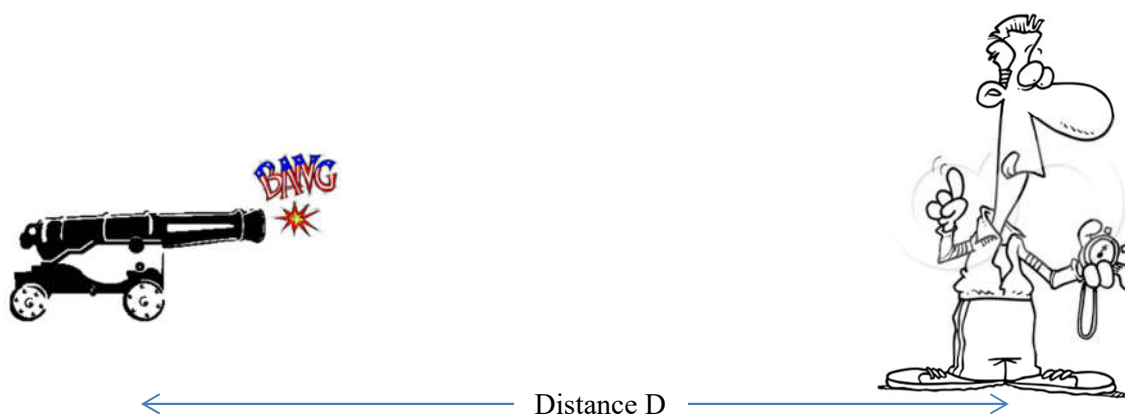

Figure 4 Measuring Distance

This is fine if the cannon just fires a single shot, but suppose the cannon is rigged to fire at regular intervals, say T seconds apart. For the sake of argument and to simplify things, let's make T equal to one. If the observer knows he is less than 340 m from the cannon there is no problem. He just makes the measurement as before and calculates the distance D. If on the other hand he is free to move anywhere and there is no restriction placed on his distance to the cannon then there is a problem. There is no way that the observer knows which bang is associated with which flash, so he might be located at any one of a number of different distances from the cannon. Not just any old distance will do however. The observer must be at a distance of D or D + 340 or D + 680 and so on, in general D + 340n. The distance calculated as a result of measuring the time interval between bang and flash is ambiguous. In fact there are an infinite number of discrete distances which could be the result of any particular measured value.

Restricting the observer to be within 340 m of the cannon is a way of imposing Shannon's sampling limit and by removing this restriction we open up the possibility of ambiguity in determining the position of the observer due to a phenomenon called aliasing.

Let's turn the problem around a little. If instead of measuring the distance to the cannon the position of the observer is fixed. Once again to make things simpler, let's choose a distance of 340m. This time however we are able to adjust the rate of fire of the cannon until the observer hears the bang and sees the flash as occurring simultaneously. If the rate of fire is one shot per second then the time taken for the slower bang to reach the observer exactly matches the interval between shots and so the two events, the bang and the flash are seen as being synchronous.

If the rate of fire is increased then at first, for a small increment, the bang and the flash are no longer in sync. They come back into sync however when the rate of fire is exactly two shots per second, and again when the rate is three shots per second. If we had a fast enough machine gun this sequence would extend to infinity for a rate of fire which is an integer number of shots per second. Notice that now the bang no longer relates to *the* previous flash, but to *a* previous flash. It is interesting to note also that if the rate of fire is reduced from once per second then the observer will never hear and see the bang and the flash in sync with one another and so once per second represents the minimum rate of fire which will lead to a synchronous bang and flash. In fact what we have here is a system that has as its solutions a base frequency and an infinite set of harmonic frequencies.

This phenomenon is called aliasing because each such occurrence where the bang and the flash coincide is an alias for the first or base solution. In the former case the variable is the distance between the observer and the cannon, while in the latter case it is the interval between the bang and the flash that is ambiguous. However in both cases all of the possible values are valid at any one time, but only one is true. The distance or the time can be said to be determinate, but not determinable.

Aliasing and Harmonic Series

In this latter example where we are altering the period and by implication the frequency of the events the aliases form a harmonic sequence. If we encounter a sampled signal whose samples are all the same value then we have no way to know whether the signal is at the sample frequency or at an integer multiple of the sample frequency. This can be seen in Figure 5 which shows how a fundamental frequency and its harmonics all return the same sampled signal, note that the sample values are all the same and depend only on the phase relationship between the signal being sampled and the sampling frequency. The important point to note here is that all of the waveforms coincide at the sampled instants even though the waveforms have different frequencies.

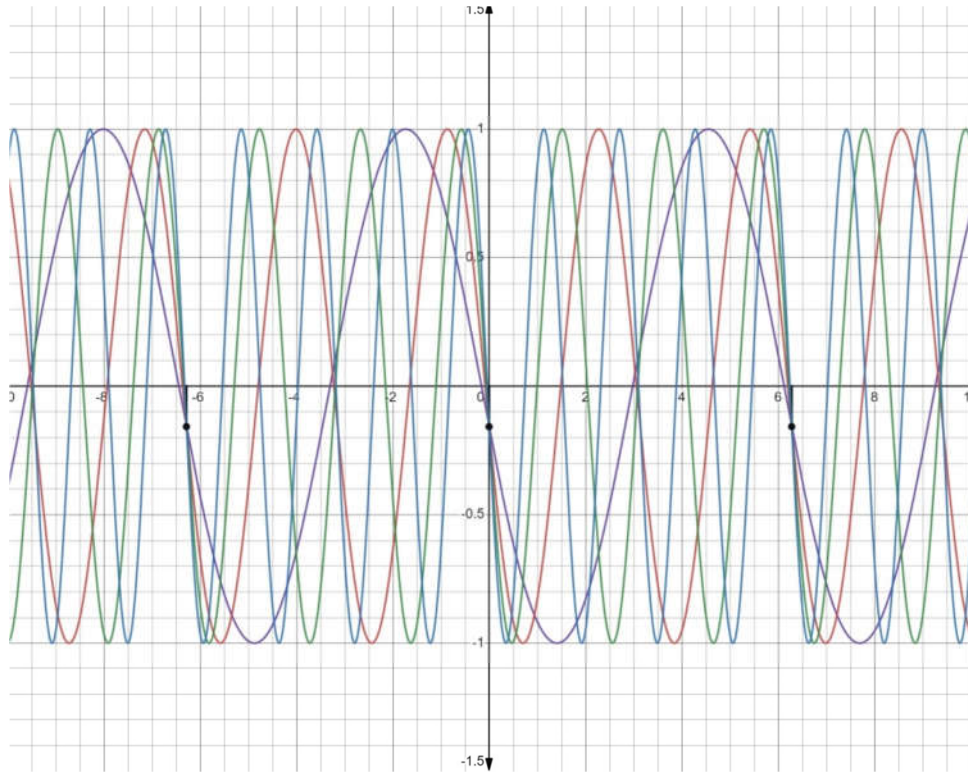

Figure 5 Sampling and Harmonics

Wherever we see a harmonic series in nature there must always be a corresponding sampling process. This becomes evident if we consider the Fourier representation of a harmonic series. Such a Fourier representation comprises a series of spikes equally spaced along the frequency axis. For a real function these are disposed equally on both the positive and negative frequency axes. These spikes are referred to as Dirac or Delta functions and such a collection of equally spaced and equally weighted Dirac functions is referred to as a Dirac comb.

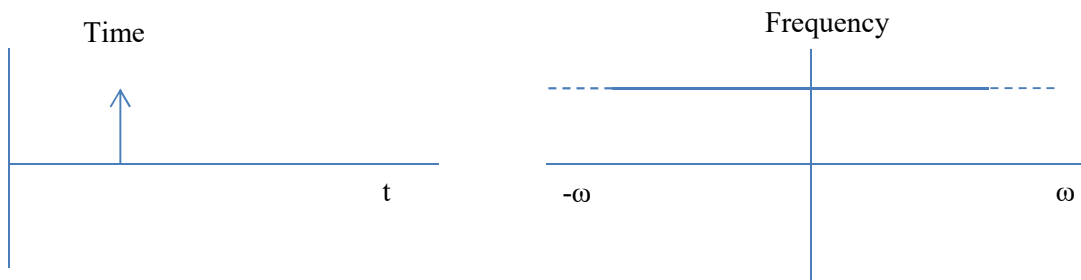

Figure 6 Fourier transform of a single Dirac function

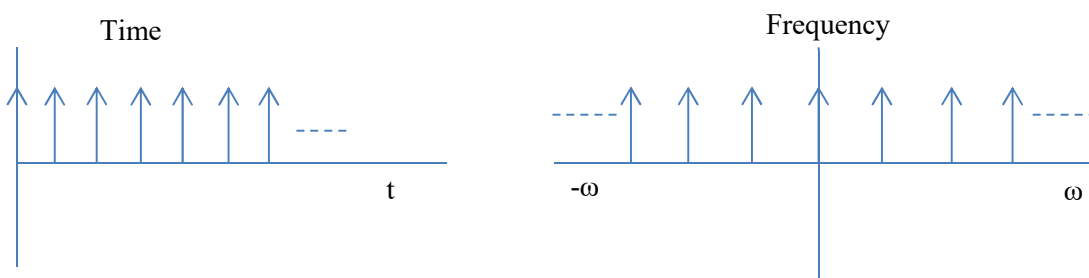

Figure 7 Fourier transform of a Dirac comb

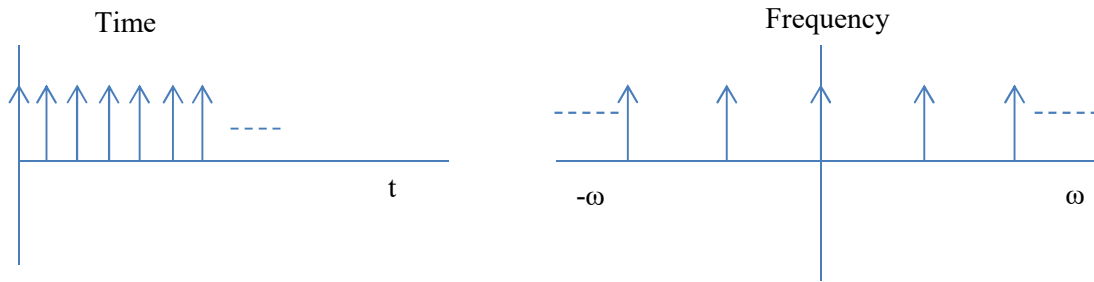

Figure 8 Fourier transform of a higher frequency Dirac comb

The Fourier transform of a Dirac comb in the frequency domain is a function in the time domain that is itself another Dirac comb⁴. Such a Dirac comb in the time domain can be regarded as a sampling function, since if it is multiplied by any other signal it effectively takes a sample at regular intervals in time. The sampling frequency corresponds to the lowest frequency in the harmonic series, which in the case of the atom is the orbital frequency of the base energy state of the atom. The orbital frequencies of the higher energy states are signals of interest and so can be regarded as aliases of this base band signal.⁴

Special Relativity and Objects in Circular Orbit

It was Albert Einstein who gave us our present understanding of how relativity affects distance, time and mass. He did so initially for objects travelling at constant speed in what is now called Special Relativity. Later on he was to deal with objects that are accelerating or decelerating in what has come to be known as General Relativity. Here we need only concern ourselves with the special case since the electron is assumed to be travelling at constant speed whenever the atom is in a stable state.

Central to the Einstein's theory of special relativity is the idea of a reference frame. A reference frame is a coordinate system used to describe the position and events in space and time. An inertial reference frame is a frame of reference in which an object either remains at rest or moves at a constant velocity, meaning it experiences no acceleration. Einstein was to postulate that the laws of physics are the same in all inertial reference frames. In adopting this second postulate Einstein had to give up on the notion that time was universal. Time according to Special Relativity ran at different rates in different reference frames, depending on how fast they were moving with respect to one another. The rate at which time advances is different for different observers depends on their relative motion. For a stationary observer time in a moving reference frame runs slower than it does in his or her own reference frame. The extent to which this occurs is a factor, Gamma, the Lorentz, factor which is given by the equation

$$\gamma = \frac{c}{\sqrt{c^2 - v^2}} = \frac{1}{\sqrt{1 - \frac{v^2}{c^2}}} \quad \text{Equation 25}$$

A graph of Gamma versus speed shows that it is close to unity for objects moving slowly but rises with increasing rapidity as the speed approaches the speed of light.

Einstein's second postulate concerned the speed of light and in a sense is merely an extension of his first postulate. Einstein postulated that the speed of light in free space is the same for any observer in any reference frame. In order to comply with the second postulate Einstein found it necessary that both distance and mass had to be affected by relativity. For a stationary observer the mass of a moving

⁴ A proof of aliasing is provided in Appendix 1

object appears greater by the factor Gamma than it does in the reference frame of the moving object, giving rise to the concept of a rest mass. Distances as measured in the reference frame of a moving observer are foreshortened by the factor Gamma.

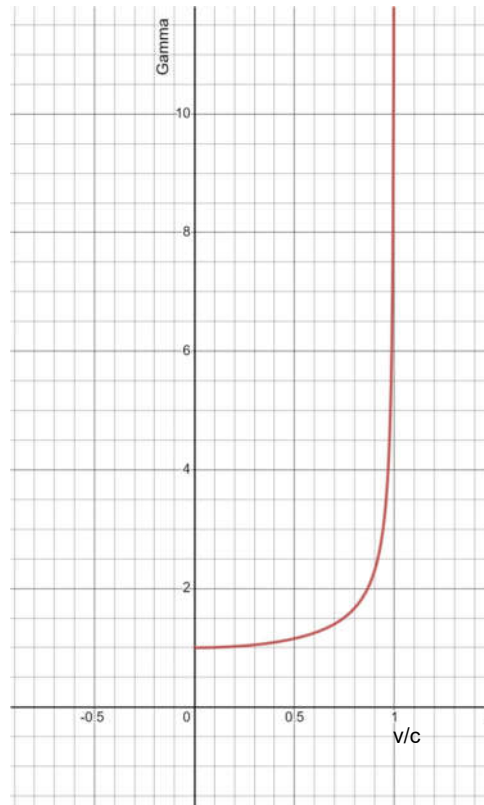

Figure 9 Gamma vs v/c

For an object travelling at 99.5% of the speed of light the value of Gamma is approximately 10. An observer traveling on such a moving object would therefore experience time at one tenth the rate of a stationary observer. The distance travelled by such an observer appears shorter by a factor of 10 and to a stationary observer the mass of an object moving at 99.5% of the speed of light appears to have increased by a factor of 10.

Speed is said to be invariant with respect to relativity. That is to say that speed is perceived by both stationary and moving observers to be the same. This comes about because speed is the result of dividing distance by time and both are equally affected in a way which cancels out.

$$v = \frac{D}{T} = \frac{d/\gamma}{t/\gamma} = \frac{d}{t} \quad \text{Equation 26}$$

The effect of relativity on distance can be difficult to visualize because it forces us into the realm of non-Euclidian geometry. Instead we can think of this as if the measurements are made with a tape measure made of elastic, the faster one travels; the more the tape measure is stretched, but only when making measurements in the direction of travel. So for the astronaut travelling at 99.5% of the speed of light, any measurements made in the direction of travel are done so with a tape measure which has been stretched by a factor of 10 and so distances will appear to be less by the factor 10.

The orbital path length is foreshortened by the Lorentz factor, Gamma, but this is simply another way of saying that it is scaled by the factor 1/Gamma. Taking the reciprocal for Gamma from Equation 25 it is evident that this is the equation of a circle, more specifically a quadrant of a unit circle since v is constrained to lie between 0 and c .

$$\frac{1}{\gamma} = \sqrt{1 - \frac{v^2}{c^2}}$$

Equation 27

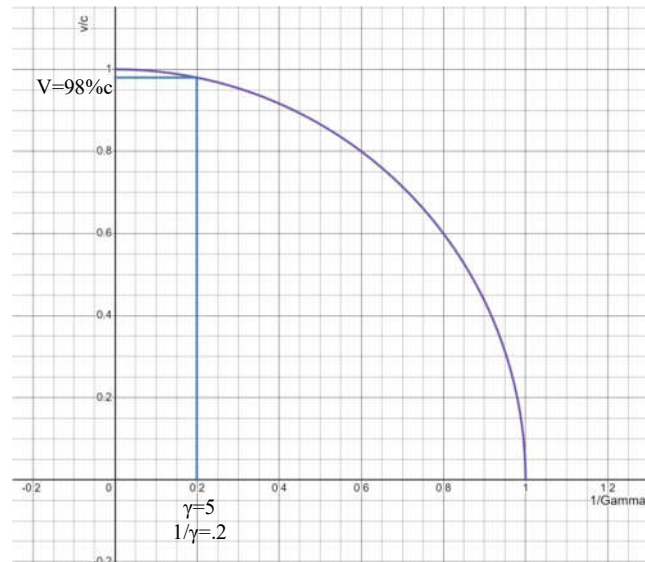

Figure 10
Reciprocal of Gamma

By superimposing this quadrant on the circular orbital path we can explore the effects of relativity on such a path.

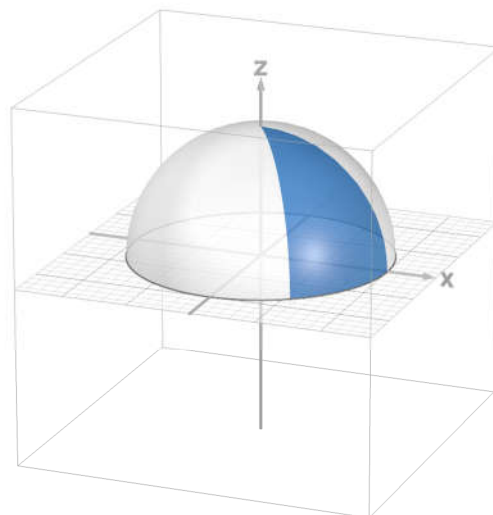

Figure 11 Spherical representation of relativity

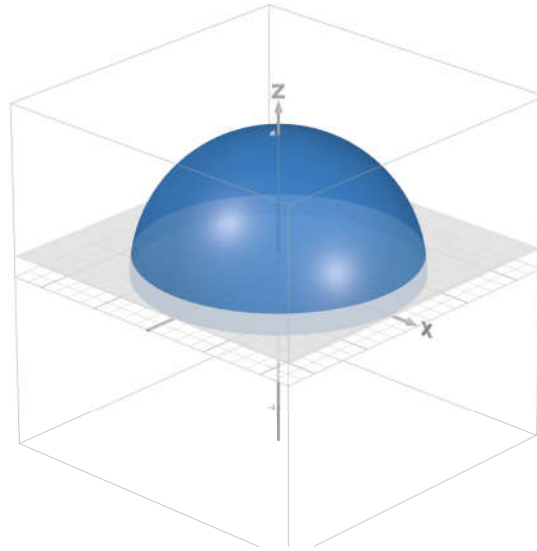

Figure 12 Effect of relativity at 15% c

Objects orbiting at non-relativistic speeds see the path length around the orbit as being equal in length to the equator, while objects orbiting at higher speeds follow a path length described by a line of latitude on the hemisphere. An object orbiting at the theoretical maximum speed of light would then be pirouetting at the pole. We can consider the length of the orbital path as being represented by the line of latitude formed by a slicing plane which cuts through the hemisphere parallel to the equatorial plane. In In Figure 12 this is at approximately 15% of the speed of light c and so the orbital path length is just a little less than the equatorial path length, around 99%.

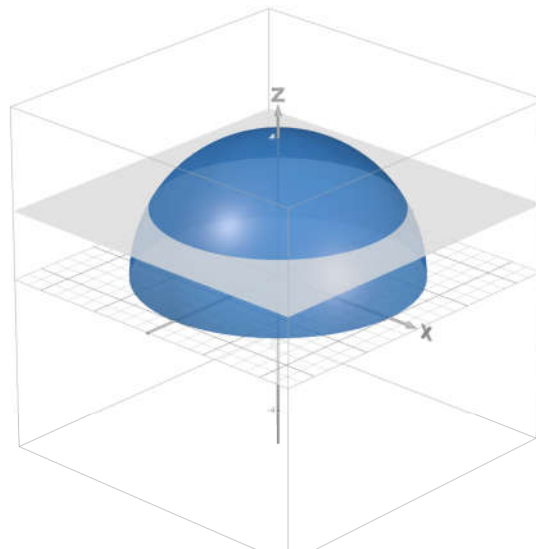

Figure 13 Effect of relativity at approx. 50% c

Figure 13 shows the situation where the orbital velocity is 50% c and so the orbital path length is approximately 70% that at the equator.

In Figure 14 the orbital velocity is around 98% of the speed of light and the corresponding orbital path length is approximately 20% of that for non-relativistic motion.

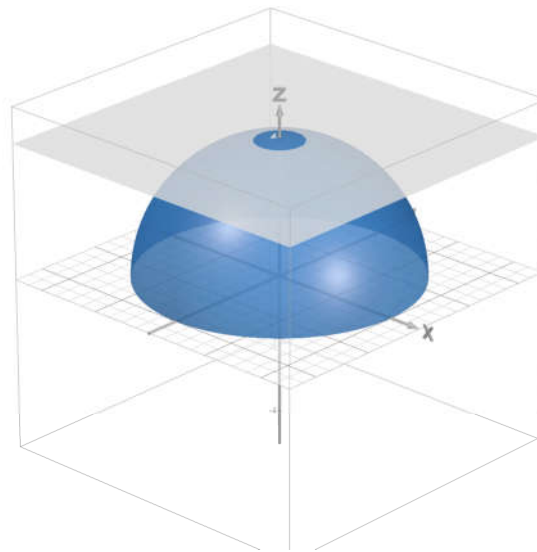

Figure 14 Effect of Relativity at Approximately 99% of c

This hemispheric model of the motion of an orbiting object is useful because it allows us to visualize the orbital path length as being foreshortened by relativity while at the same time the radius of the orbit is unaffected by relativity, being the distance to the center of the sphere. The orbital geometry is non-Euclidian and in reality all takes place in just one plane. The introduction of this third dimension is just a device to allow us to visualize what is going on. The orbiting object sees the distance it travels around one orbit as being reduced by a factor Γ , but nevertheless sees the orbital radius as being unaffected by relativity since this is at right angles to the direction of travel.

The elastic tape measure analogy can be extended to include such a circular orbital path if we do this for all of the possible lines of latitude on the hemisphere we get a projection of the sphere onto a cylinder. As before this allows us to visualize the effect of relativity without distorting the geometry of space.

Instead of regarding distance as being compressed, the distance scale that is regarded as being stretched then the hemisphere of Figure 15 is transformed into a cylinder. This cylindrical representation can then be unwrapped to create a flat two dimensional mapping in much the same way that a map projection can be used to draw the surface of a spherical earth onto a flat piece of paper. This is exactly analogous to the elastic tape measure described above.

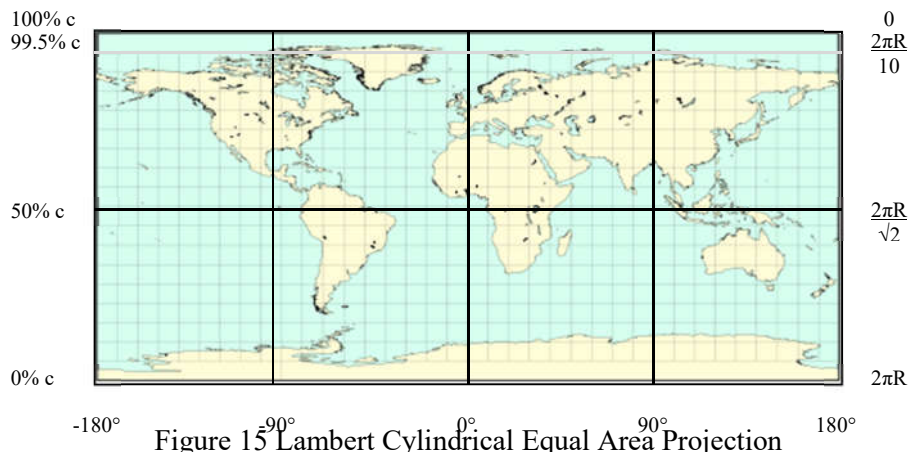
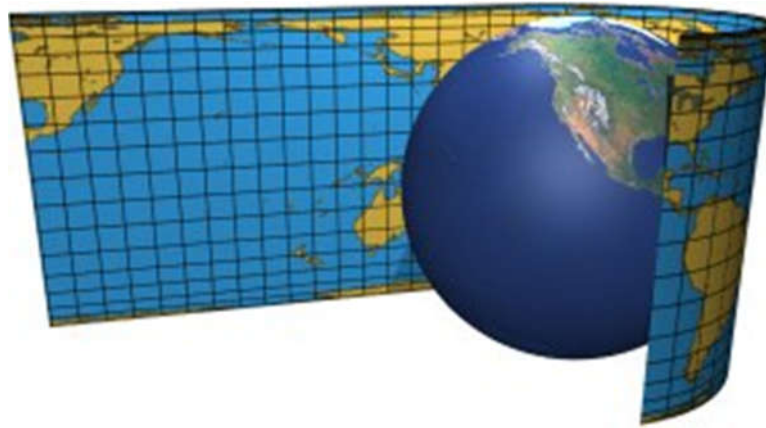

Figure 15 Lambert Cylindrical Equal Area Projection

The distance around the equatorial orbit is referred to here as the Actual Distance travelled by the astronaut. The distance as it is perceived by the astronaut, compressed by the factor Gamma is referred to as the Relativistic Distance.

The combined effect of relativity and sampling

We can now start to see how aliasing and relativity can combine to produce an atom with stable states, first by considering things on a terrestrial scale and then on the scale of the atom.

Consider an astronaut in orbit around the earth. His spacecraft orbits along a great circle and we ask how far he has to travel before we observers on the surface of the earth see him overhead. The circumference of the earth is some 40,000 km, so at first glance it would seem that the answer to the question is 40,000 km, but this is only a partial answer. Nobody said that the measurement was restricted to a single orbit and so 80,000 km would be an equally valid answer as would 120,000 km and so on. In general we could write a simple formula to describe all of the possible such distances:

$$d = 40000n \quad \text{Equation 28}$$

Where $n = -\infty \dots -5, -4, -3, -2, -1, 0, 1, 2, 3, 4, 5, \dots \infty$

It is important to understand that all of these aliases are valid at any one time. Every time the astronaut passes overhead it is correct to say that we have travelled 40,000 km, 80,000 km, 120,000 km etc. since he/she was here before. Furthermore since the starting point and endpoint could be chosen arbitrarily anywhere along the great circle route, it is true for any starting point along the chosen path. So no matter where we are on the great circle it is correct to say that we have travelled 40,000 Km, 80,000 Km, 120,000 Km etc. since we were here before. Notice however that the start and end points must coincide.

However even this falls short of a complete answer to our question because in our imaginary orbiter he/she can travel as fast or as slow as we like. The distances measured so far are measured at a low speed where the effects of relativity are negligible. But if he/she was to travel much faster, at close to the speed of light, then the distance he/she perceived travelling in the orbiter is reduced or foreshortened.

The Effect of Relativity

Earlier we saw how relativity affects the perception of distance travelled. Einstein showed that distances measured in the direction of travel are foreshortened or compressed, those at right angles to the direction of travel are unaffected. The extent of this foreshortening is governed by the Lorentz factor.

We saw also that, rather than imagine that the distance between points changes, it is sometimes easier to imagine instead that the scale on which distance is measured is stretched. It is as if the measurements are made with a tape measure made of elastic, the faster one travels; the more the elastic tape measure is stretched, but only when making measurements in the direction of travel. So for the astronaut travelling at 99.5% of the speed of light, any measurements made in the direction of travel are done so with a tape measure which has been stretched by a factor of 10 and so distances will appear to be less by the factor 10.

The dynamic range of Gamma extends from 1, at very low speeds, all the way to infinity at the speed of light. In effect this means that, by suitable choice of the orbital velocity and the number of orbits, we can contrive the distance around the earth from point A to point A to be anything we care to make it.

So the correct answer to the question: How far is it around the world? Is:

How far do you want it to be?

How far *do* you want it to be?

Suppose we want to choose a particular distance around the world and then to explore all of the possible strategies for achieving it. If, for example, we want to find all the possible ways of travelling from A to A while covering a distance of 400 Km. One possible strategy would be to complete one orbit of the earth at speed where Gamma has a value of 100. That would be at a speed of 99.995% of the speed of light. The next viable solution would be to complete two orbits at a speed where Gamma equals 200, that is at 99.99875% of the speed of light. The next would be three orbits at Gamma = 300 and so on. In general we can summarize this as

$$\gamma = 100n \qquad \text{Equation 29}$$

For $n = 1, 2, 3, \dots \infty$

There are thus an infinite number of ways in which we could contrive to go around the world while covering a distance of 400 Km. Once again for each successive value of Gamma the distances around the world are aliased. For example when $n = 1$ the distances are **400**, 800, 1200... km, when $n = 2$ they are 200, **400**, 600... km and when $n = 3$ they are 133, 266, **400**, 533...km. For each value of n all of the respective values are valid, it is just that we are choosing the particular alias where the distance equals 400 km. In fact the distances we are choosing represent a harmonic series. The situation is summarized in Table 1 which shows the possible distances for values of Gamma which are an integer multiplier of 100 and for n orbits. The principle diagonal is always equal to 400 km, our chosen distance.

γ	1	2	3	4	5	6	7
100	400.00	800.00	1200.00	1600.00	2000.00	2400.00	2800.00
200	200.00	400.00	600.00	800.00	1000.00	1200.00	1400.00
300	133.33	266.67	400.00	533.33	666.67	800.00	933.33
400	100.00	200.00	300.00	400.00	500.00	600.00	700.00
500	80.00	160.00	240.00	320.00	400.00	480.00	560.00
600	66.67	133.33	200.00	266.67	333.33	400.00	466.67
700	57.14	114.29	171.43	228.57	285.71	342.86	400

Table 1 Distances Under Relativity

It is left to the reader to work out the various strategies for circumnavigating the earth while covering a distance of 291.9 km.

Relativistic Velocity and Sampling

The conventional wisdom holds that both the stationary observer and the moving observer agree on their relative velocity, that velocity is invariant with respect to relativity. Such invariance is axiomatic to the derivation of Special Relativity.

To measure the speed of an object moving at close to the speed of light in real time it is necessary for a stationary observer to use two clocks, at least conceptually. One clock must be set up at the point of departure and another at the point of arrival. The two clocks must then be synchronized before the measurement can begin⁵. The time that the moving object leaves the point of departure is noted on the departure clock and the time of its arrival is noted on the arrival clock. At least one of these measurements must then be transmitted to the other location before the difference can be taken and the speed calculated. Any attempt to measure such a velocity in real time is thwarted by the fact that the clock would have to move with the moving object and so would itself be slowed down due to the effects of relativity.

There is however one circumstance where this is not the case, where it is possible to measure velocity using just a single clock; that is when the moving object is in orbit. Under such circumstances the object returns to its point of origin once per orbit and so it is possible, conceptually at least, to measure its orbital velocity in real time using a single clock provided the measurement is made over one or more complete orbits. Any attempt to measure the speed between two separate points on the circumference is thwarted by the same two clock problem outlined above. The restriction that orbital period can only be measured or experienced over a whole number of complete orbits amounts to a sampling process and, as we have seen, sampling processes lead to aliasing.

Using this as a starting point and combining it with the effects of relativity on orbital motion, it is possible to define a hybrid velocity term which straddles the two reference frames; that of the stationary observer and that of the moving electron. Such a velocity is calculated as the distance measured by the moving observer, and foreshortened by relativity, divided by the time as measured or experienced by the stationary observer. Hence this 'Relativistic Velocity' term is also reduced by a factor of Gamma compared to the Actual Velocity as measured within the two respective reference frames and is invariant.

⁵ Since the two clocks are stationary with respect to one another they will run at the same rate and therefore it is possible to synchronize them.

Within the reference frame of the stationary user the normal conditions apply and the orbital velocity is seen as being close to the speed of light. The same is true for the electron within its frame of reference. Hence Relativistic Velocity only applies when considering phenomena which act between the two reference frames. Therefore it is postulated that this type of Relativistic Velocity is what applies when calculating momentum, angular momentum, centripetal and centrifugal force and acceleration.

When orbital velocity is measured over a complete orbit, the distance value which contributes to the measurement of velocity is subject to aliasing in exactly the same way as the measurement of the distance around the earth was earlier. The orbital period however is measured in the reference frame of the stationary observer and so is not subject to aliasing. The orbiting electron has no inbuilt counter and cannot count the orbits, it is only capable of relating the distance travelled to the time taken once per orbit and since the distance travelled is subject to aliasing then so is the effective orbital velocity. This means that the distance travelled during the orbital period can be regarded as having multiple values but this also means that so does the Relativistic Velocity which is distance divided by time and just as when orbiting the earth, all of these aliased values can be considered as being valid at the same time.

The Hydrogen Atom

Returning to the Newtonian equations, we can consider how these two factors; relativity and sampling, might combine to explain the mechanics of the atom.

The Newtonian force balance equation is

$$\frac{Kq^2}{R^2} = \frac{mv^2}{R} \quad \text{Equation 30}$$

However it is necessary to take into account the effects of relativity and it is postulated that the orbital velocity is close to the speed of light and so is affected by relativity. Under such circumstances the mass of the electron would be increased by a factor Gamma. The velocity term is taken to be the Relativistic Velocity and so is the Actual Velocity reduced by the same factor Gamma and so

$$\frac{Kq^2}{R^2} = \frac{m\gamma c^2}{R\gamma^2} \quad \text{Equation 31}$$

This simplifies to

$$\frac{Kq^2}{R^2} = \frac{mc^2}{R\gamma} \quad \text{Equation 32}$$

John W Nicholson argued that the orbital angular momentum of the electron was equal to Planck's constant. He based this idea on the fact that Planck's constant has units which are the same as those for angular momentum. He further assumed that the orbital angular momentum of the electron could take on values which were an integer multiple of this. However it is this latter assumption which leads directly to the idea of the quantum leap. Here it is argued that the quantum leap is a physical impossibility and so the idea of quantizing angular momentum is rejected in favour of Gamma being the variable of quantization. However the idea that the orbital angular momentum is equal to Planck's constant remains valid and so we can develop an expression for the orbital radius directly from this definition of Planck's constant. Again the mass term is affected by relativity and the velocity term by the inverse:

$$\hbar = m\gamma r \frac{c}{\gamma} \quad \text{Equation 33}$$

From which

$$\hbar = mrc \quad \text{Equation 34}$$

And since \hbar , m and c are all constants, it follows that the orbital radius is constant and is numerically $3.86159 \cdot 10^{-13} \text{ m}$. This value is not unknown, it is sometimes referred to as the Reduced Compton Wavelength; the Compton Wavelength is then the orbital circumference.

$$R = \frac{\hbar}{mc} \quad \text{Equation 35}$$

Substituting for R in Equation 32 and simplifying gives

$$\frac{Kq^2}{\hbar c} = \frac{1}{\gamma} \quad \text{Equation 36}$$

Alpha has been calculated analytically based on the value of other well-known constants and is given by

$$\alpha = \frac{Kq^2}{\hbar c} \quad \text{Equation 37}$$

Where K is the Coulomb force constant and q is the charge on the electron and the proton.

So

$$\alpha = \frac{1}{\gamma} \quad \text{Equation 38}$$

From this we can calculate both the Actual Velocity and the Relativistic Velocity in the base energy state. The actual orbital velocity is 99.9973372% of c . The Actual Velocity for the infinite energy state is c itself and so the dynamic range of the Actual Velocity is extremely narrow.

The Relativistic Velocity is the Actual Velocity multiplied by Alpha, the Fine Structure Constant, and is therefore $2\pi R\alpha/T$. Numerically it is 2187309.8 m/s, a value that is known as the Bohr velocity as it is the same velocity as the electron in the base energy state of the Bohr model.

But from Equation 24 $\gamma_n = \frac{n}{\alpha}$ so it is necessary to consider why, if $\alpha = \frac{1}{\gamma}$ is a solution $\alpha = \frac{n}{\gamma}$ should also be a solution?

Why n/Alpha is a solution if 1/Alpha is a solution

The orbit of the electron is stable if the Relativistic Velocity is such that the effective orbital velocity is scaled by Gamma to be equal to $2\pi R\alpha$, the Bohr velocity..

Imagine that you are an observer located on the atomic nucleus of a hydrogen atom. At some time $t = 0$ you look up and the electron is directly overhead. Then some time later when $t = T$ you look up again, if you see the electron directly overhead then the atom is in a stable state. Its effective orbital velocity, its Relativistic Velocity, will be the distance that it has traveled around the orbit divided by the time T and one of the aliases for this velocity will be equal to the Bohr velocity. If you do not see the electron after time T , then the position of the electron is undefined, the effective orbital velocity will not be equal to the Bohr velocity and the atom will not be in a stable state.

The situation for the base energy state is shown in Figure 16

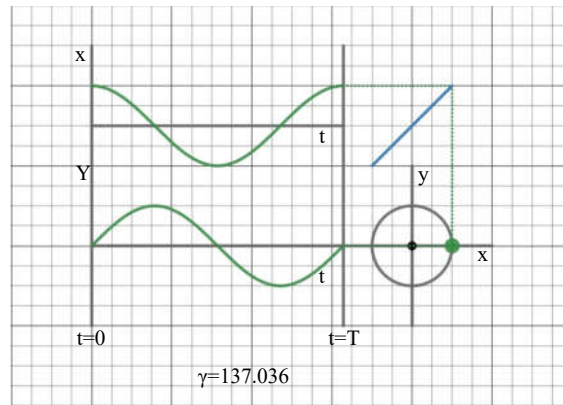

Figure 16 The Base Energy State

The electron completes one orbit between observations. The orbital period is T and is measured in the reference frame of the stationary observer located on the nucleus. Gamma has a value of 137.036 and the orbital path length is foreshortened by relativity to be $2\pi R\alpha$ and so the orbital velocity is equal to the Bohr velocity such that the atom is stable and the electron is seen to lie on the positive x axis, corresponding to it being directly overhead when observed at both $t = 0$ and $t = T$.

If we increase the actual orbital velocity by some small amount then Gamma will increase and the orbital path length, the wavelength, will be foreshortened so when the observer looks for the electron at time $t = T$ it is not there. The actual orbital velocity is very close to the speed of light and so a relatively small change in Actual Velocity will produce a large change in Gamma. As far as the observer is concerned the position of the electron is undefined and the atom will not be in a stable state. The situation is shown in Figure 17⁶. The green trace shows the position of an electron orbiting in the base energy state. The red trace shows the position of an electron orbiting at a higher speed in this case where Gamma has a value of 164. The position of the electrons coincides at time $T = 0$, but after an interval of time T , their positions no longer coincide. For an observer located at nucleus, if the electron was directly overhead at time $t = 0$, it is not overhead T seconds later and so the both the position and the velocity are undefined and so the electron will not be in a stable state.

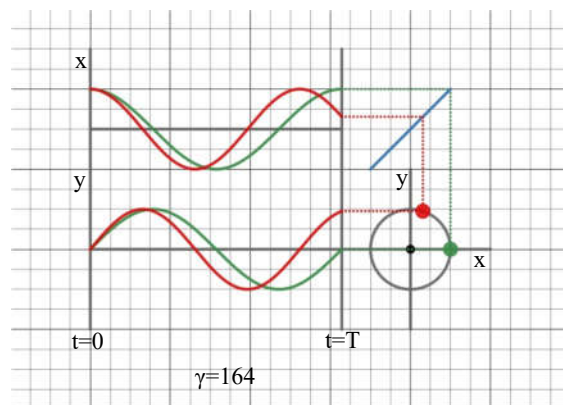

Figure 17 An Unstable State

The situation persists as we increase the actual orbital velocity and corresponding value of Gamma until Gamma reaches a value of 274.072 at which point the observer located on the nucleus will see

⁶ I have deliberately chosen to represent the situation using real values for both x and y in order to emphasise the fact that the electron is a real object and the x,y co-ordinates are real values. I could equally have chosen to represent the position of the electron in the complex plane simply by asserting that the y dimension is imaginary. The results would be the same with the stable atom corresponding to the positive real axis.

the electron directly overhead at both $t = 0$ and $t = T$ where once again the electron is seen to lie on the positive x axis in Figure 18. The wavelength has been foreshortened by relativity to the extent that two cycles now fit in the space of the wavelength of the base energy state. The electron is incapable of counting and in any event the observer is not able to look for the electron at any time other than $t = nT$ and so is not able to discriminate between the situation where the atom is in the base energy state or the second energy state.

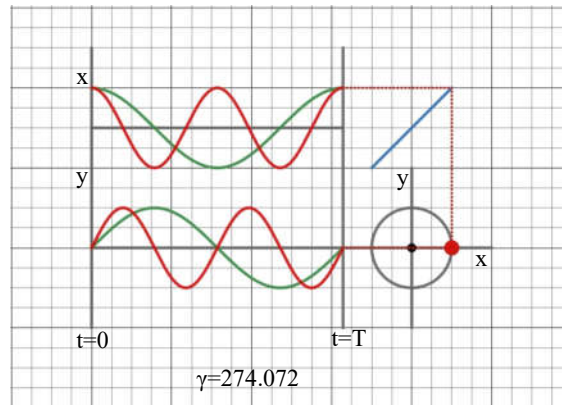

Figure 18 The Second Energy State

As Gamma increases beyond 274.072, the pattern will repeat such that the atom will not be stable until Gamma reaches $3 * 137.036$. The situation for this third energy state is shown in Figure 19, where $\gamma = 411.108$.

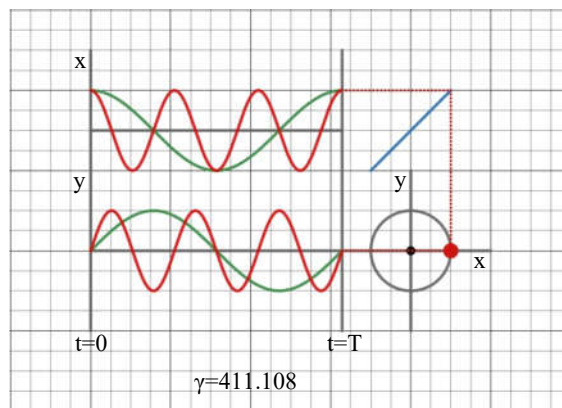

Figure 19 The Third Energy State

In the base energy state the atom is stable because Gamma has a value of $1/\alpha = 137.036$ which causes the centrifugal force to match the electrostatic force. Figure 17 to Figure 19 show that when the value of Gamma is an integer multiplier of this base value the atom is also stable. And so the stable states of the atom correspond to those orbital velocities where Gamma has a value of n/α .

Because the sampling takes place at the same frequency as the base energy state the sample values are the same at every sample interval. This is consistent with the electron being directly overhead at the time the samples are taken. The effect of introducing a phase change is shown in Figure 20. The sample values have altered, but remain the same as each other at every sample instant. Such a phase change does not affect the outcome, but merely represents a change in which direction is regarded as being overhead by an observer at the nucleus.

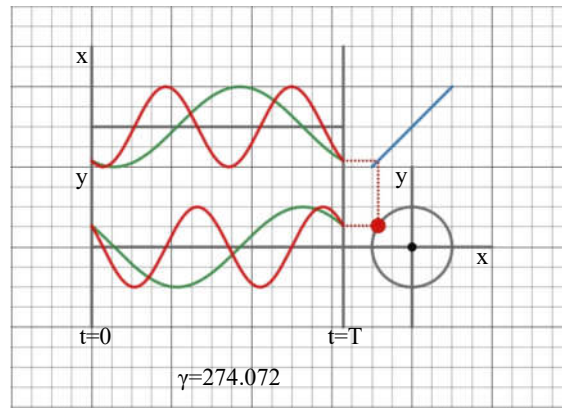

Figure 20 The Effect of a Phase Shift

The interval T is a common factor when describing Relativistic Velocity and so we can conduct similar analysis in terms of the wavelengths of the waves in Figure 16 to Figure 20 rather than frequency to construct a time independent solution to the wave equation simply by dividing each velocity term by T . In this case it is evident that the atom is stable when a whole number of the wavelengths of the waves foreshortened by Gamma equals that of the wave foreshortened by $1/\alpha$ in the base energy state. The Relativistic Velocity is always equal to the foreshortened orbital path length divided by the same orbital period and so this time independent solution is in fact the same as the time dependent solution.

There are striking similarities between this and the solution of Schrödinger's wave equation. In both cases the solution lies in finding the value of a parameter which results in a whole number of waves fitting within another wave. In Schrödinger's case the waves to be fitted are those of de Broglie and the wave they fit into is the circumference of the Bohr orbit for that particular energy state. Here the corresponding waves are those whose wavelength is foreshortened by relativity in the n^{th} state must fit within the wavelength of the base energy state. This is where the similarities end.

Wave Equation

When Erwin Schrödinger developed his wave equation he was forced to base it around a travelling wave. This is because the notion of de Broglie's waves is that they travel around the orbit of the electron and that it is only at certain frequencies that the wavelengths of these waves add up to the orbital circumference and become standing waves. These standing waves correspond to the stable energy states of the atom. Schrödinger is thus forced to adopt a canonical form for his equation which includes two partial derivatives, one for time and one for distance, rather than the one derivative term needed here. This necessarily complicates the Schrödinger equation, whereas here we are dealing with the simple case of a harmonic oscillator in which the distance is the displacement with respect to some mean value.

Schrödinger faced a second constraint and that is that he assumed that changes in the energy level of the atom were accompanied by a change in potential energy of the electron, in effect acknowledging the existence of the quantum leap. This forced Schrödinger to postulate a solution to his equation which can only be described in the complex plane. The measurement problem then arises as physicists try to coerce this complex equation to have real solutions. The electron is said to exist in a state of superposition, where its exact position and momentum not only cannot be determined, but does not even exist. When observed however the electron 'collapses' from this indeterminate state as a wave front to exist as a real particle. The so called Measurement Problem is a question of how and whether the wave front collapse occurs. The question defies rational explanation and has confounded both physicists and philosophers alike.

With the introduction of Relativistic Velocity, the need for a quantum leap disappears. The electron is seen as a point particle having deterministic properties. The electron orbits at a constant radius,

irrespective of the energy level and as a consequence there is no change in potential energy between the various energy states, only the kinetic energy of the electron changes. The result is a simple planetary model for the electron, albeit one which involves relativity. This greatly simplifies any wave equation we might develop to describe the position of the electron as a function of time. There is no need to introduce the idea of a travelling wave and no change in orbital radius. The equation is that of a simple undamped second order system.

This is readily solved by first postulating a solution of the form $x = R \cos(\omega t)$ from which

$$\frac{dy}{dx} = -R\omega \sin(\omega t) \quad \text{Equation 39}$$

And

$$\frac{d^2x}{dt^2} = -R \omega^2 \cos(\omega t) \quad \text{Equation 40}$$

Hence

$$x = R \cos(\omega t) \quad \text{Equation 41}$$

And the resulting equation is

$$x = -\frac{R}{\omega^2} \frac{d^2y}{dx^2} \quad \text{Equation 42}$$

From the force balance equation

$$\frac{Kq^2}{R^2} = \frac{mv^2}{R\gamma} \quad \text{Equation 43}$$

From this we can develop an expression for v^2

$$v^2 = \frac{Kq^2\gamma}{Rm} \quad \text{Equation 44}$$

Multiplying both sides by $1/c^2$

$$\frac{v^2}{c^2} = \frac{Kq^2\gamma}{Rmc^2} \quad \text{Equation 45}$$

Recognizing that $\hbar = mRc$ and that $\alpha = \frac{Kq^2}{\hbar c}$

$$\frac{v^2}{c^2} = \alpha\gamma \quad \text{Equation 46}$$

From the Lorentz formula

$$\frac{v^2}{c^2} = \frac{\gamma^2 - 1}{\gamma^2} \quad \text{Equation 47}$$

Eliminating the v^2/c^2 term between Equation 46 and Equation 47 gives

$$\alpha\gamma^3 - \gamma^2 + 1 = 0$$

Equation 48

The numerical value⁷ for α is $7.2973525693 \times 10^{-3}$. Substituting this and calculating the three roots for $n = 1$ gives:

$$\begin{aligned}\gamma &= 137.028700954 \\ \gamma &= -0.99638422226 \\ \gamma &= 1.00368235217\end{aligned}$$

Of the three roots, the first is the one corresponding to the orbit of the electron. However it falls slightly short of the value of $1/\alpha$ necessary for it to complete one orbit during the orbital period measured in the stationary reference frame. The reason for this is that the electron is travelling at slightly less than the speed of light. To a first approximation the velocity of the electron is given by

$$\frac{v}{c} = \sqrt{\frac{\gamma^2 - 1}{\gamma^2}} = 0.999973373968267 \quad \text{Equation 49}$$

The situation is shown in Figure 21 this shows a graph of the cubic Equation 48 where the inset shows that the root does not exactly correspond with the value $1/\alpha$ on the x axis.

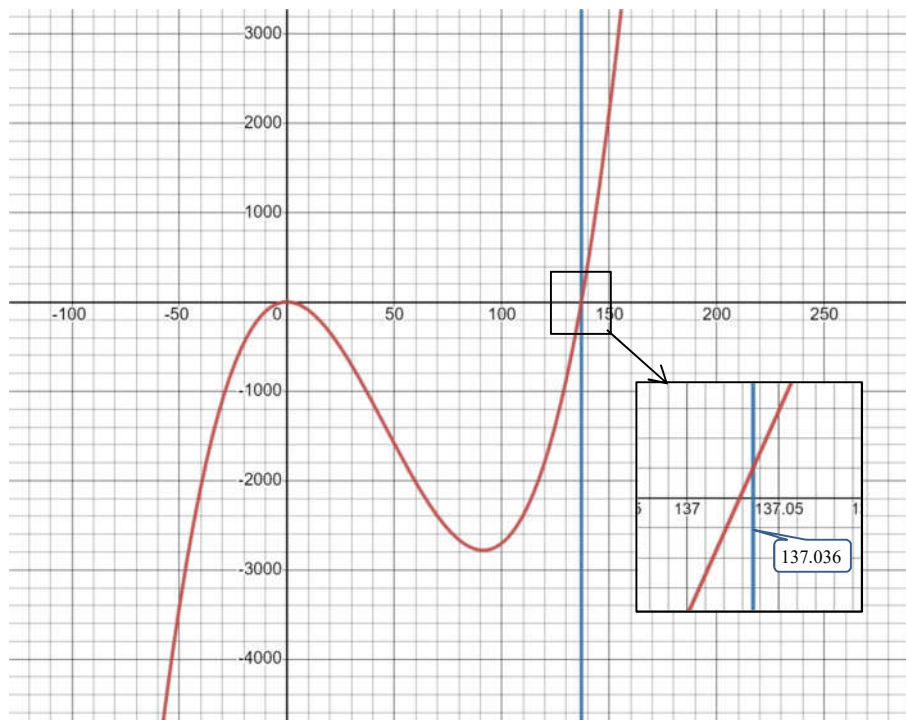

Figure 21 Graph of Cubic

The reason for this discrepancy concerns the value of Alpha, the fine structure constant. Alpha is a theoretical value predicated on the assumption that the electron is traveling at exactly light speed when in fact it is travelling at slightly less than light speed. As a consequence using the reciprocal of Alpha as the scale factor of the orbital circumference leads to this small shortfall. We can correct for this by increasing the speed a small amount. Such a change will of necessity change the value of Gamma which will far outweigh any change in the speed itself.

⁷ CODATA - <http://physics.nist.gov/cgi-bin/cuu/Value?alpha>

There are a number of ways in which we might try to calculate this adjustment, but by far the simplest is iteration. Using Alpha and 1/Gamma as starting values, we can calculate the error and apply this to obtain an adjusted value for Gamma and from this an adjusted value for Alpha. The process is convergent and so we simply repeat this process until the error reaches zero.

$$\text{Alpha} = 0.0072973525693$$

$$\text{Gamma} = 137.035999083696$$

	Root of Cubic	Shortfall	Adjusted Gamma	Adjusted Alpha
Gamma 1	137.028700917629	0.00729816606648	137.043297249762	0.00729696395277
Gamma 2	137.035999508603	-0.00000042490720	137.043296824855	0.00729696397539
Gamma 3	137.035999083671	0.00000000002481	137.043296824880	0.00729696397539
Gamma 4	137.035999083696	0.00000000000000	137.043296824881	0.00729696397539

Table 2 Iterative Steps to Calculate Adjusted Gamma

From this the adjusted orbital velocity in the base state using Equation 47 is
 $v/c = 0.99997337680397$

From Equation 46

$$\frac{v^2}{c^2} = \alpha\gamma = 0.99997337680397^2 = 0.99994675431674 \quad \text{Equation 50}$$

Hence we can correct the equation to take account of the fact that $v < c$

$$\gamma = \frac{1}{\alpha} 0.99997337680397^2 = \frac{1}{\alpha} * 0.99994675431674 \quad \text{Equation 51}$$

Thus far the cubic Equation 48 deals with only the base energy state. We can modify this to deal with all of the other energy states by substituting n/α in place of $1/\alpha$ as the coefficient of the cube term and repeating the iterations for each energy state.

Figure 22 shows the family of curves plotted for the first ten values of n where it can be seen that the curves each intersect the x axis at an integer multiple of $1/\alpha$.

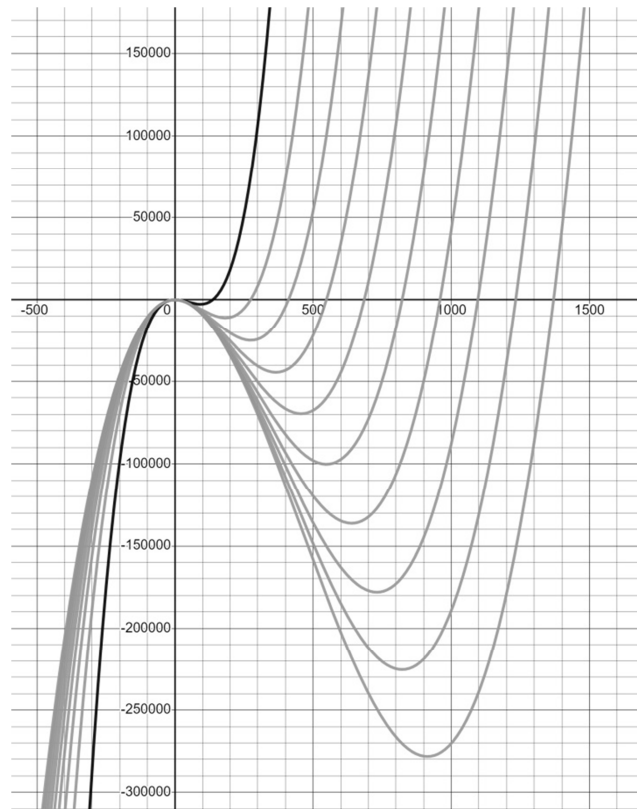

Figure 22 Graph of $y = \frac{\alpha}{n} \gamma^3 - \gamma^2 + 1$

Table 3 gives the value of Gamma for each of the stable states of the atom. Each row represents a stable state of the atom and the columns show all of the aliases for the Relativistic Velocity in that state. It can be seen that one value is highlighted in each row and that it is equal to the Bohr velocity. Hence in each stable state there is an alias for the Bohr velocity which results in a value for the centrifugal force which exactly balances the electrostatic force.

We have seen that the value of Gamma that leads to stability is slightly less than $1/\alpha$. This is because each stable state of the atom is slightly less than the speed of light and approaches the speed of light for the theoretical infinite energy state.

n Gamma	1	2	3	4	5	6	7
Relativistic velocities							
137.036	2187309.8	4374619.5	6561929.3	8749239.1	10936548.8	13123858.6	15311168.4
274.720	1093654.9	2187309.8	3280964.7	4374619.5	5468274.4	6561929.3	7655584.2
411.108	729103.3	1458206.5	2187309.8	2916413.0	3645516.3	4374619.5	5103722.8
548.144	546827.4	1093654.9	1640482.3	2187309.8	2734137.2	3280964.7	3827792.1
685.180	437462.0	874923.9	1312385.9	1749847.8	2187309.8	2624771.7	3062233.7
822.216	364551.6	729103.3	1093654.9	1458206.5	1822758.1	2187309.8	2551861.4
959.252	312472.8	624945.6	937418.5	1249891.3	1562364.1	1874836.9	2187309.8

Table 3 Relativistic Velocities for the Stable States of the Atom

In other words it is precisely because Gamma increases with increasing orbital velocity causing the centrifugal force to decrease with increasing velocity that these various states each become stable for some value of orbital velocity.

From Equation 49 we can calculate the orbital velocity in each energy state and from this we can calculate the orbital frequency, the energy and the energy potential in each state as shown in Table 4.

n	v_n/c	γ_n	ω_n	Energy eV	Energy Potential eV
1	0.9999733776803	548.145820680354	7.7632391423E+20	255485.925	13.607
2	0.9999933437358	274.075646892332	7.7633941477E+20	255496.130	3.402
3	0.9999970416220	411.110429716811	7.7634228560E+20	255498.020	1.512
4	0.9999983359049	548.145820680228	7.7634329041E+20	255498.682	0.850
5	0.9999989349769	685.181454892904	7.7634375550E+20	255498.988	0.544
6	0.9999992603998	822.217210731314	7.7634400814E+20	255499.154	0.378
7	0.9999994566199	959.253036067305	7.7634416047E+20	255499.255	0.278
∞	1.0000000000000	0.000000000	7.763451838E+20	255499.532	0.000

Table 4 Orbital velocity, frequency and energy

The orbital velocity for $n = 1$ is 99.997337680397% of c and that for the infinite energy state is c itself, which means the dynamic range of orbital velocity is extremely small. This, together with the fact that the orbital radius is constant means that the morphology of the atom remains substantially the same for all energy states. This is important because the physical and chemical properties of the atom are independent of the energy state and this is not likely to be the case if the morphology of the atom was significantly different from state to state.

Balance of Forces

As the Actual Velocity increases, in a very small dynamic range close to the speed of light, the Relativistic Velocity decreases. This causes the centrifugal force to decrease the result is that the centrifugal force varies as the inverse of Gamma. In addition to this reduction in force with Gamma, the centrifugal force is subject to aliasing caused by sampling. Figure 23 shows a plot the family of curves of force against Gamma for the first 10 states together with a line representing the electrical force, which is not affected by Gamma. Each point where the curves intersect the line represents a stable state of the atom.

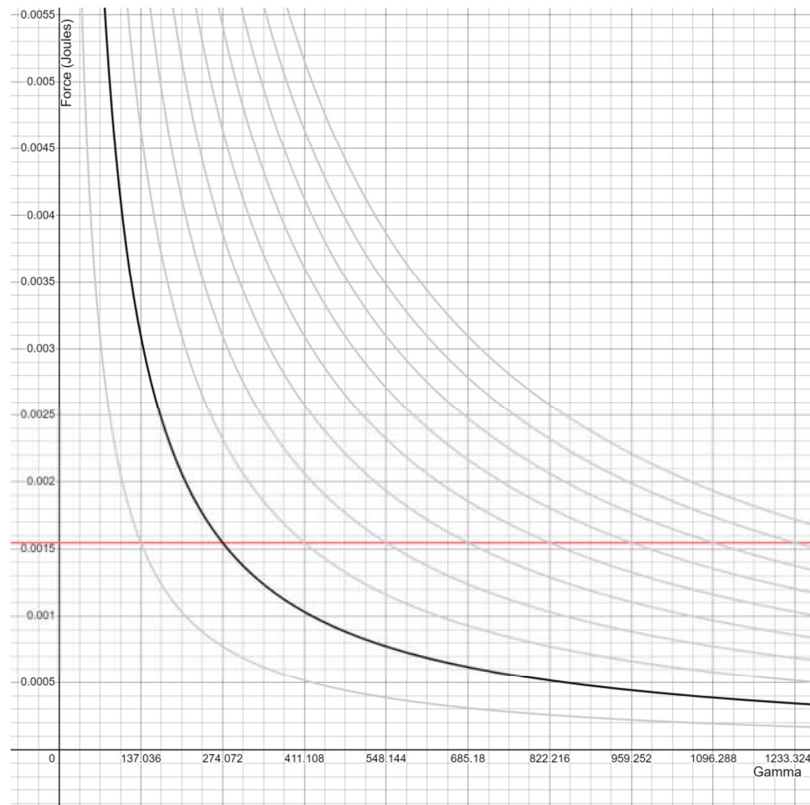

Figure 23 Family of Curves of Force vs Gamma

The vertical separation between these curves gives an indication of the force necessary to cause a change in energy level. From this it will be seen that the force required to cause an increase in energy level is always more than the force required to cause a decay between any pair of states.

The Absence of Synchrotron Radiation

When an electrically charged particle, such as an electron or an ionized atom follows a curved path we expect it to emit a type of radiation called synchrotron radiation. This is the expected norm, but the electron orbiting the hydrogen nucleus does not, despite it following a circular path. For an isolated particle, such as an atomic nucleus or even an isolated electron, the curved path occurs as a result of interactions between the particle and the surrounding atoms. In the case of the atom however we are dealing with forces which act within the atom itself.

The dynamics within the atom are different to those of an atom interacting with other atoms, the laws are the same, but the circumstances are different. The electron within the atom is orbiting at near light speed and so subject to the effects of relativity. We have argued that the atom is stable if the effective orbital velocity is seen to be affected by relativity and scaled by a factor of $1/\text{Gamma}$ and it is the presence of this Gamma term in the denominator of the term for centrifugal force which leads to the absence of synchrotron radiation.

The forces acting on the electron are the electrical force of attraction and the centrifugal force. These must be equal for the electron to be in balance. But we can consider what happens if there is a small change in the orbital radius while the orbital angular velocity remains constant.

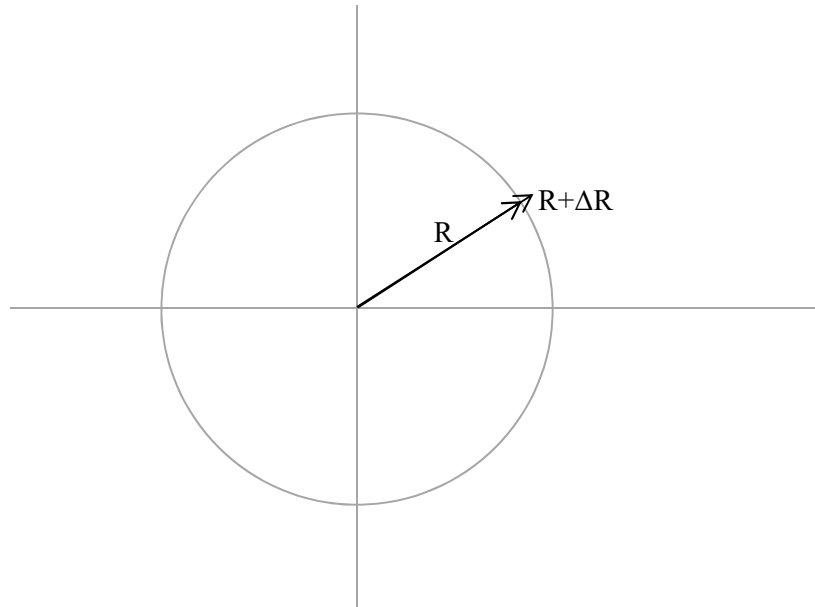

Figure 24 A small change in orbital radius

From Equation 32 the total force acting on the electron is given by

$$f = \frac{m\omega^2 R}{\gamma} - \frac{Kq^2}{R^2} \quad \text{Equation 52}$$

However Gamma is a function of both R and ω . And when we correctly insert this into the equation for the total force acting on the electron becomes

$$f = \frac{m\omega^2 R \sqrt{c^2 - \omega^2 R^2}}{c} - \frac{Kq^2}{R^2} \quad \text{Equation 53}$$

A small change in the orbital radius R at constant angular velocity will lead to a corresponding change in the velocity term ωR this in turn will lead to a change in the value of Gamma. Gamma is extremely sensitive to changes in the velocity and so this will lead to a relatively large change in the value of Gamma and, since Gamma is in the denominator of the term for centrifugal force, this will in turn lead to a large change in the centrifugal force. The change is such that if the radius is increased then the centrifugal force is reduced and vice versa. This change in the value of centrifugal force far outweighs any change in the electrical force due to the small change in radius and so the result is that any deviation from the orbital radius results in a strong force acting to restore the orbital radius of the electron to its equilibrium value.

We can assess the extent of this force by calculating the partial derivative of the force in Equation 53 with respect to R while the angular velocity remains constant.

The first step is to recognize that

$$f = A + B$$

Where $A = \frac{m\omega^2}{c} R\sqrt{c^2 - \omega^2 R^2}$ and $B = -\frac{Kq^2}{R^2}$ and so $\frac{\partial f}{\partial R} = \frac{\partial A}{\partial R} + \frac{\partial B}{\partial R}$

$$\frac{\partial B}{\partial R} = \frac{2Kq^2}{R^3} \quad \text{Equation 54}$$

To find the partial derivative of A with respect to R we must invoke the chain rule $\frac{\partial f}{\partial R} = \frac{\partial f}{\partial P} \frac{\partial P}{\partial R}$

$$A = \frac{m\omega^2}{c} (R^2 c^2 - \omega^2 R^4)^{\frac{1}{2}} \quad \text{Equation 55}$$

Let $P = R^2 c^2 - \omega^2 R^4$

Then $A = \frac{m\omega^2}{c} P^{\frac{1}{2}}$

$$\text{So } \frac{\partial A}{\partial P} = \frac{P^{-\frac{1}{2}}}{2} = \frac{m\omega^2}{c} \frac{1}{2R\sqrt{c^2 - \omega^2 R^2}}$$

$$\text{And } \frac{\partial P}{\partial R} = 2(c^2 R - 2\omega^2 R^3) = 2R(c^2 - 2\omega^2 R^2)$$

$$\text{But } \frac{\partial A}{\partial R} = \frac{\partial A}{\partial P} \frac{\partial P}{\partial R}$$

Hence

$$\frac{\partial A}{\partial R} = \frac{m\omega^2}{c} \frac{c^2 - 2\omega^2 R^2}{\sqrt{c^2 - \omega^2 R^2}} \quad \text{Equation 56}$$

And for the total residual force we can combine Equation 54 and Equation 56 to give

$$\frac{\partial f}{\partial R} = \frac{m\omega^2}{c} \frac{(c^2 - 2\omega^2 R^2)}{\sqrt{c^2 - \omega^2 R^2}} + \frac{2Kq^2}{R^3} \quad \text{Equation 57}$$

However since $\omega^2 R^2 \approx c^2$ we can substitute in Equation 57 to give

$$\frac{\partial f}{\partial R} = -m\omega^2 \frac{c}{\sqrt{c^2 - \omega^2 R^2}} + \frac{2Kq^2}{R^3} \quad \text{Equation 58}$$

$$\frac{\partial f}{\partial R} = -m\omega^2 \gamma + \frac{2Kq^2}{R^3} \quad \text{Equation 59}$$

We can calculate the size of this rate of change of force with orbital radius at the orbital radius:

$$\frac{\partial f}{\partial R} = -7.524 * 10^{13} \text{ N/m}$$

The negative sign indicates that the residual force always acts so as to drive the electron back to orbital equilibrium.

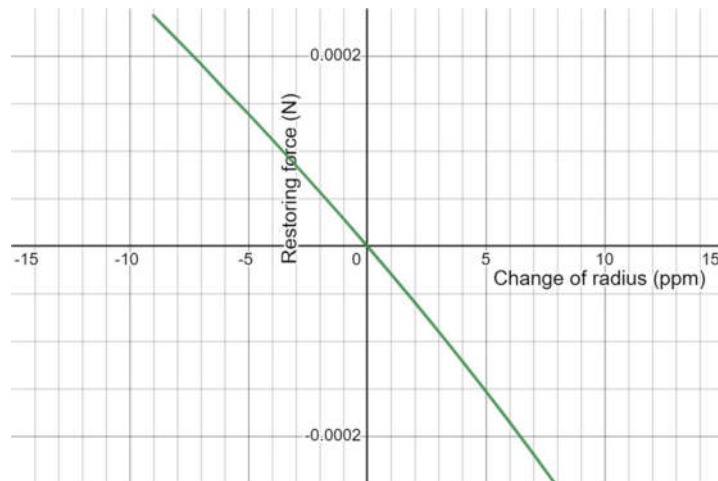

Figure 25 Restoring force vs Change of Radius

The situation is shown graphically in Figure 25 which plots the restoring force in the region of the orbital radius. Compared to the mass of the electron and to the electrical and centrifugal forces when these are in balance, this is a huge force. The change in the total restoring force is some 7000 times larger than the change in the electrical force alone. A change of just 80 ppm in the orbital radius would lead to a doubling of the centrifugal force if that change were inwards and to a complete elimination of the centrifugal force if it were in the other direction. To all intents and purposes the electron is orbiting around a solid surface, which it cannot penetrate and from which it cannot deviate.

The above calculation is for the base energy state where Gamma has a nominal value of 137.036 since Gamma has a higher value at higher energy levels, the force acting on the electron becomes even higher.

The Uncertainty Principle

Werner Heisenberg formulated his uncertainty principle based on analysis of the dynamics of the hydrogen atom. He arranged the terms for momentum and position in a grid or matrix, but when he came to manipulating them he discovered (or rediscovered) a quirk of matrix arithmetic: that multiplication is not commutative; in other words $[A]*[B] \neq [B]*[A]$. The difference he ascribed to uncertainty; the idea that it is not possible to measure both momentum and position at the same time to an arbitrary degree of accuracy. There is always a tradeoff between these two measurements.

Eventually Niels Bohr adopted this idea as a way to try to circumvent the problem he had encountered with the quantum leap, arguing that uncertainty was somehow intrinsic to the electron. That it does not exist as a particle in the classical sense, but somehow is spread around in multiple places at once and that it is only when it is observed that it is transformed into a particle having both position and velocity. The electron is said to exist as a wave front in a state of quantum uncertainty or superposition, where it is deemed not to be located at a single point, but to occupy a region in space. When it is subject to an observing process, the state of uncertainty or non-locality 'collapses' such that the electron manifests itself as a particle in a particular location. The measurement problem is a question of whether and how such a wave front collapse occurs

The Observer Effect

To gain a complete understanding of uncertainty and the measurement problem it is first necessary to consider the so-called 'observer effect'. When making a measurement, it is essential for the tools being used to make the measurement do not affect the measurement. The normal way to get around this problem is to ensure that the resolution of the measuring tool is much finer than the tolerance to

which the measurement is being made. Unfortunately on the scale of the electron there are no such tools available. The only tools available are other electrons and photons and these are of the same order of magnitude as the electron being measured. The observer effect confounds any practical attempt to make measurements on this scale and it is often confused with the underlying problem of uncertainty, which is different to the observer effect. While we cannot practically make measurements on this scale, we can imagine what is happening to the various particles involved as if we were able to do so.

Shortly before Heisenberg published his findings on uncertainty, Erwin Schrödinger had developed an equation which described the particle in terms of a wave. At the time there was an element of competition between Heisenberg and Schrödinger. The uncertainty principle gave Heisenberg a clear lead, however eventually Schrödinger was able to show that his wave equation could be used to derive the same expression for uncertainty as that of Heisenberg – and that in fact the two methods are equivalent.

The Cauchy Schwarz Inequality

While the uncertainty inequality can be derived from the Schrödinger wave equation or from Heisenberg's matrix mechanics, a far simpler solution can be found by recognizing that the inequality is based on the Cauchy Schwarz inequality^{vi}. This concerns the relationship between the expected values of the two variables and their product and is commonly written as

The uncertainty equation is an inequality. It says that the average value of the position of the electron multiplied by its average momentum must always be greater than or equal to Planck's constant divided by two.

$$\Delta x \Delta p \geq \frac{\hbar}{2} \quad \text{Equation 60}$$

If we expand the terms this equation can be written as

$$\Delta x \Delta m v \geq \frac{m v r}{2} \quad \text{Equation 61}$$

$$E(a)E(b) \geq E(ab) \quad \text{Equation 62}$$

Expected value, denoted by E , is a measure of the deviation of a variable from its average value and is sometimes referred to as standard deviation of the variable. The expected value of x is well understood in the world of signal processing and electrical engineering where it is referred to as the Root Mean Square (RMS) of the value.

The position of the electron can be described in terms of its x, y components

$$X = x, y \quad \text{Equation 63}$$

Then the velocity of the electron can be described as

$$V = \frac{dx}{dt}, \frac{dy}{dt} \quad \text{Equation 64}$$

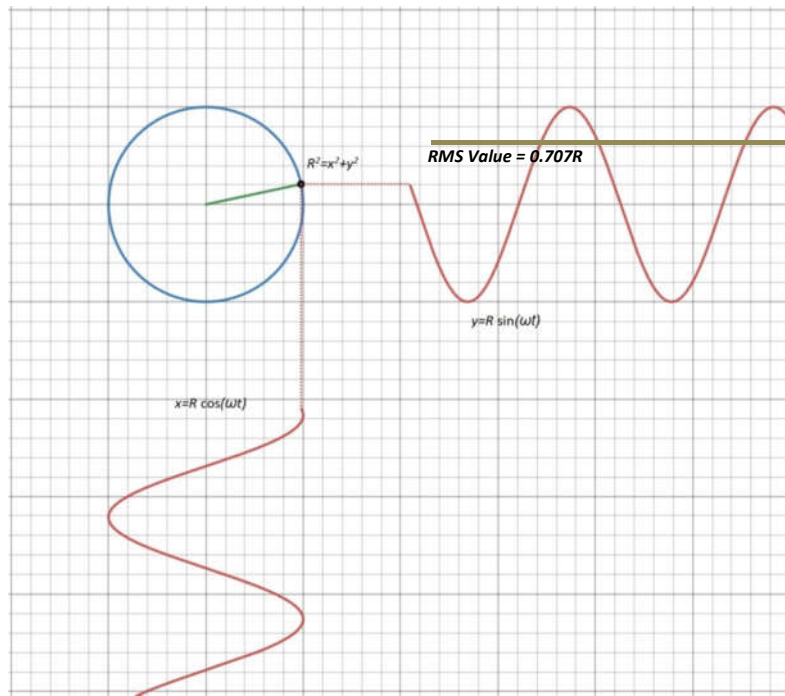

Figure 26 Parametric equations for the orbiting electron

The position of the electron can be resolved into two sinusoidal waves, one in x and one in y.

$$x = R \sin(\omega t) \quad \text{Equation 65}$$

$$y = R \cos(\omega t) \quad \text{Equation 66}$$

In general the standard deviation of a periodic variable which is a function of time is given by

$$\sigma f(t) = \sqrt{\frac{1}{2\pi} \int_0^{2\pi} f(t)^2 dt} \quad \text{Equation 67}$$

We must calculate this separately for each of the two components and then combine these results to obtain the overall standard deviation.

And so the standard deviation of the position in the x axis is given by

$$\sigma(x) = \sqrt{\frac{R^2}{2\pi} \int_0^{2\pi} \cos^2(\omega t) dt} \quad \text{Equation 68}$$

From which

$$\sigma(x) = \frac{R}{\sqrt{2}} \quad \text{Equation 69}$$

Similarly the standard deviation in the y axis

$$\sigma(y) = \frac{R}{\sqrt{2}} \quad \text{Equation 70}$$

These can be combined as a root sum square to give the overall standard deviation of position as

$$\Delta X = \sqrt{\left(\frac{R}{\sqrt{2}}\right)^2 + \left(\frac{R}{\sqrt{2}}\right)^2} \quad \text{Equation 71}$$

$$\Delta X = R \quad \text{Equation 72}$$

In other words the orbital radius is constant. (Note here we are talking about the orbital radius within a stable state and not between stable states, which is also constant)

The linear momentum of the orbiting electron is given by

$$L = mv \quad \text{Equation 73}$$

Which we can resolve into x and y components in a manner similar to that for position.

$$L_x = -mR\omega \sin(\omega t) \quad \text{Equation 74}$$

$$L_y = mR\omega \cos(\omega t) \quad \text{Equation 75}$$

The calculation for momentum then follows a similar argument, except for the presence of the constant m , the mass of the electron and the ω term which occurs as a result of differentiating the distance to get the velocity and gives

$$\Delta L = m\omega \sqrt{\left(\frac{R}{\sqrt{2}}\right)^2 + \left(\frac{R}{\sqrt{2}}\right)^2} \quad \text{Equation 76}$$

And so

$$\Delta L = mV \quad \text{Equation 77}$$

This is also constant.

On the RHS we must find the average value of the product of the position and the momentum. Again we can resolve into x, y components for position and velocity and calculate the average for each component and then combine them into an overall average.

$$xmv_x = mvR \sin(\omega t) \cos(\omega t) \quad \text{Equation 78}$$

And

$$ymv_y = -mvR \cos(\omega t) \sin(\omega t) \quad \text{Equation 79}$$

$$\sigma(L_x) = mvR \sqrt{\frac{1}{2\pi} \int_0^{2\pi} (\sin \omega t \cos \omega t)^2 dt} \quad \text{Equation 80}$$

$$\sigma(L_x) = \frac{mvR}{\sqrt{8}} \quad \text{Equation 81}$$

We can do the same for $\sigma(xL_y)$ and then combine x and y components to give the overall standard deviation using a root sum square

$$\sigma(L_y) = \frac{mvR}{\sqrt{8}} \quad \text{Equation 82}$$

$$\Delta(L) = \sqrt{\left(\frac{mvR}{\sqrt{8}}\right)^2 + \left(\frac{mvR}{\sqrt{8}}\right)^2} \quad \text{Equation 83}$$

From which

$$\Delta(L) = \frac{mvR}{2} \quad \text{Equation 84}$$

$$\Delta(L) = \frac{\hbar}{2} \quad \text{Equation 85}$$

Applying these to the Cauchy Schwartz inequality gives the familiar expression for uncertainty

$$\Delta X \Delta L \geq \frac{\hbar}{2} \quad \text{Equation 86}$$

$$R \Delta L \geq \frac{\hbar}{2} \quad \text{Equation 87}$$

The product of the RMS value for the displacement and the RMS value for the velocity multiplied by the mass of the orbiting body is always greater than or equal to half of the orbital angular momentum.

This is universally true for any orbiting body, although most commonly it is an equality. For example the derivation works equally well for all of the energy levels in the Bohr model for the atom, so if R is the Bohr radius and V the Bohr velocity we see that the n's on the LHS effectively cancel

$$\Delta R n^2 \Delta m \frac{V}{n} \geq \frac{n\hbar}{2} \quad \text{Equation 88}$$

From Equation 61 it is evident that the mass term is plays no part in the uncertainty. It is a constant. It is present on both sides of the inequality in order that the RHS can be expressed in terms of Planck's constant. Cancelling the mass term gives the more fundamental form which expresses the uncertainty between position and velocity for an orbiting body.

$$\Delta x \Delta v \geq \frac{vr}{2} \quad \text{Equation 89}$$

The Cauchy Schwartz inequality is familiar to electrical engineers where it forms the basis of the calculation of the Power Factor, the ratio of the useable power to the product of volts and current and it is useful to draw comparisons with Heisenberg's inequality. The displacement, x, corresponds to the voltage in an AC circuit, and the velocity, v, corresponds to the current. The inequality is used to describe the power factor. The RMS value of the voltage in volts multiplied by the RMS value of the current in amps is always greater than or equal to the RMS value of the product of voltage and current; the power in watts. The ratio of these two quantities is termed the power factor and is given by

$$\text{Power factor} = \frac{W}{VA} \quad \text{Equation 90}$$

Power factor is always less than or equal to one and is derived from the Cauchy Schwartz inequality in exactly the same way as with the uncertainty inequality. If we look at how the inequality deviates from being an equality it is evident that the frequency is the same for both voltage and current. The peak values and therefore the amplitude remain constant. The only variable which is then unaccounted is the phase relationship between voltage and current, and this is indeed what leads to a power factor of less than unity,

$$E(\text{volts})E(\text{amps}) \geq E(\text{watts}) \quad \text{Equation 91}^8$$

In the terms on the LHS of the inequality, the phase is integrated out separately for each of the two variables, whereas on the RHS the phase relationship is expressed by virtue of the multiplication of the two terms prior to the integration and so is affected by the phase relationship.

In the case of power factor the ‘uncertainty’ is expressed in terms of a phase shift between the two signals, volts and amp. However in the case of the orbiting electron this cannot be the case and so we must look elsewhere to find the root cause of uncertainty. This is because the phase relationship between the velocity and the position of an orbiting object is always 90 degrees.

We can express the uncertainty or rather its reciprocal, the certainty, in a similar manner as the ratio of the average of the product to the product of the averages.

$$\text{Certainty} = \frac{\hbar}{2\Delta x \Delta p} \quad \text{Equation 92}$$

At first sight it would appear that all of the terms in this equation are constant. Planck’s constant is just so, the orbital radius is constant and coincidentally is the same for all energy states and the orbital velocity is constant. More important the phase relationship between the position and the velocity is constant at 90 degrees.

In order for the inequality to exist it is necessary that the position variable is periodic, it must be single valued and piecewise continuous and differentiable^{9 vii}. The fact that it must be single valued is of particular interest, since it is not consistent with the idea that the electron can be in more places than once at any one time. This means that the electron has to always be somewhere, it cannot be in more than one place at a time and it cannot be spread out everywhere. In other words the electron must be localized. To argue otherwise is to challenge the very notion of velocity as the first derivative of position with respect to time and to challenge 350 years of calculus.

This raises some interesting questions about the physical nature of uncertainty and in particular as to how uncertainty can come about. The solution is again to turn to the properties of a sampled signal and in particular an under sampled signal, that is one where the frequencies of interest fall beyond the Shannon limit.

Looking again at the inequality

$$\Delta x \Delta p \geq \frac{\hbar}{2} \quad \text{Equation 93}$$

⁸ Note that the absence of the factor ½ in this equation is because voltage and current are in phase with one another whereas velocity and position are 90 degrees out of phase.

⁹ Piecewise continuous means that there can be discontinuities in the derivative function but not in the position function as for example if the position were a triangle wave, then the velocity function would be a square wave.

The two factors on the LHS of the inequality are constants irrespective of the fact that the position of the electron is sampled. This is because we are sampling the position of the electron once per cycle and that is also the period over which we integrate to determine the average value. It therefore doesn't matter how many complete cycles of the x and y components of the position or velocity signals are completed within the sample period just as long as it is a whole number.

This is not the case on the RHS of the inequality. In the base state of the atom the RHS of the equality is also valid and equal to $\hbar/2$. This is because we are sampling just one complete cycle of the position and the velocity and so the analysis is exactly as before. The implication of this is that in the base energy state there is no uncertainty.

Things are different in the higher energy states. Here we are not able to make a direct connection between the position of the electron and the orbital period. It will always be deemed to have completed more than one orbit during the orbital period. We can however calculate a value for the term based on that of the base state by noting that

$$E = \frac{1}{2}mv^2 = mvR\omega \quad \text{Equation 94}$$

And so

$$\frac{\hbar}{2} = \frac{E}{\omega} \quad \text{Equation 95}$$

Here we are concerned with the foreshortened distance which contributes to the Relativistic Velocity for the stable states of the atom this is a harmonic series and so

$$\omega = \omega_1 n \quad \text{Equation 96}$$

Which means that

$$\Delta x \Delta p \geq \frac{E}{\omega_1 n} \quad \text{Equation 97}$$

From this we see that uncertainty is nothing to do with the phase relationship between position and velocity but instead is the result of aliasing due to sampling and that the degree of uncertainty is closely related to the energy level rising with increasing energy level.

We can show graphically how the various trajectories that the electron might be following relate to one another. First we define a term $\tau = \frac{nt}{\alpha}$ and then plot the position of the electron against τ for each successive value of n. What this does is to show us how the electron perceives the orbital paths in the reference frame of the stationary observer by scaling the time axis such that 2π represents one orbital period in the domain of the stationary observer: Figure 27.

Figure 28 shows the situation in the base energy state where $n = 1$. In this state there is no uncertainty. If we know that the electron is in this state then we can glean its position from the sampled values. This is because at least in theory we can calculate the position of the electron based on knowing that only one orbit is completed between sample points and this is reflected in the fact that there is only a single ordinate value for each value of the abscissa no matter where we look along the τ axis.

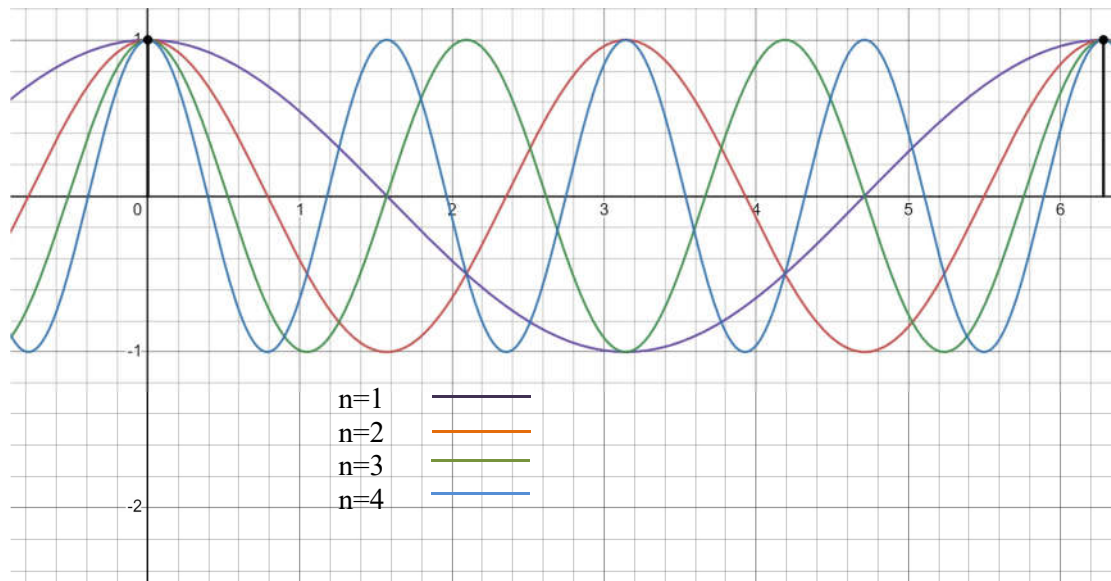

Figure 27 Electron Trajectories for $n=1-4$

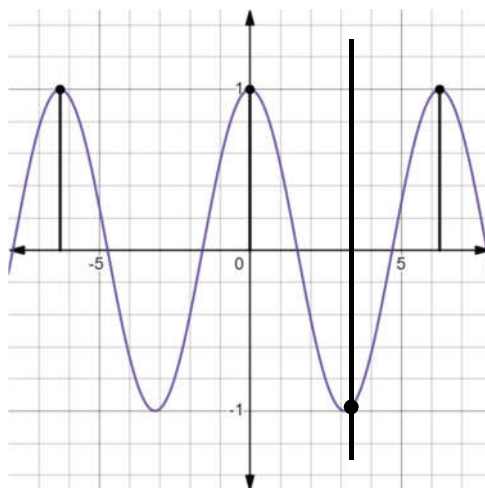

Figure 28 Uncertainty in the Base Energy State

In the second energy state there are two ordinate values for each value of the abscissa except at the sample instants as shown in Figure 29.¹⁰

¹⁰ The graph shows the situation in the x axis, but when we consider both x and y axes there are always two points where they coincide.

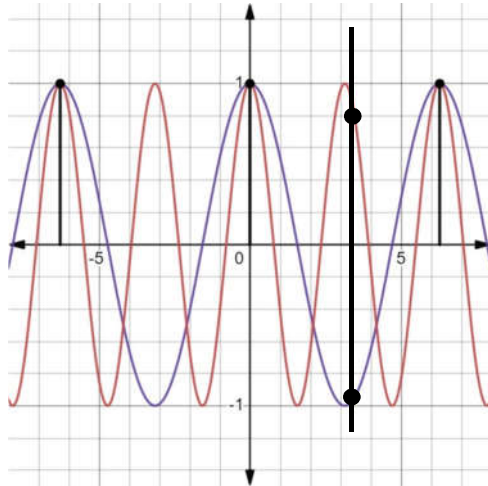

Figure 29 Uncertainty in the Second Energy State

The pattern continues and so for the third energy state there are three values for the ordinate for each value of the abscissa except at the sample instant, as shown in Figure 30. In general there are n possible values of the ordinate for each value of the abscissa in the n^{th} energy state. And so the higher the energy state the greater the degree of uncertainty.

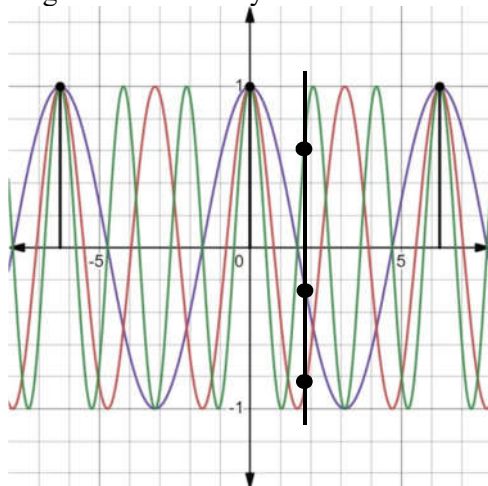

Figure 30 Uncertainty in the Third Energy State

The uncertainty stems from the ambiguity associated with the sampling process and it increases with energy state.

When Heisenberg first set out the uncertainty principle, he ascribed uncertainty entirely to the observer effect; in other words he felt that the process of making the one measurement necessarily affected the other and that was the complete story. Later he was persuaded that uncertainty was somehow intrinsic to the electron. That is, the electron did not exist as a discrete particle. Here we see that the two effects are inseparable. The state of the electron is unknown until it is involved in some sort of interaction. Such an interaction necessarily involves an observation process and incurs the observer effect and that the state of the electron must change in some way as a result of the interaction. But even without the observer effect the state of the electron is uncertain because of the ambiguity that occurs as a consequence of the position and velocity being sampled.

Schrödinger's cat

In his thought experiment the eponymous cat is locked in a sealed box together with an atomic device that has 50% probability of releasing an alpha particle in a one hour period. If the alpha particle is emitted it triggers a device which releases a vial of poison which kills the cat. The commonly held

belief is that during the one hour period the cat is both alive and dead at the same time and is neither alive nor dead.

The cat and the vial of poison are really just a form of amplifier designed to indicate the alpha particle emission on a human scale. A Geiger counter hooked up to some sort of recorder would work equally well, but Schrödinger was looking for a dramatic effect to ridicule the Copenhagen interpretation and so we will stick with his cat. The emission of the alpha particle, should it happen, is a discrete event, it either happens or it doesn't during the one hour of the experiment. If it does happen then it does so at a specific time, it is just that we are not able to observe it during the one hour period that the box is sealed.

The two events, placing the cat in the box and opening it one hour later are in reality two samples taken one hour apart in a sampling regime that notionally samples the vital signs of the cat one per hour. The vital signs of the cat can then be thought of as a continuous analog signal that is sampled at intervals of one hour. When a signal is sampled in this way the state of the signal between samples, the inter sample value, is undefined. At any instant in time the cat is either alive or dead. It is never in a state of limbo. It is our knowledge, or lack of knowledge of the state of the cat that is uncertain, not the cat itself.

Couched in these terms it is evident that Schrödinger's cat is almost a perfect textbook example of the application of Shannon's Sampling Theorem. This states that the sampling rate must be twice the highest frequency of interest in the sampled signal, which in this case are the vital signs of the cat. The uncertainty arises because the signal is under sampled, that is the bandwidth of the signal is higher than the Shannon limit, resulting in uncertainty.

In the case of the electron orbiting the hydrogen atom, the sample rate is fixed by the dynamics of the system. There is nothing we can do to increase the sample rate and so reduce the uncertainty.

Superposition and the Measurement Problem

The requirement for the position of the electron to be a single valued function of time means that it always has a deterministic position, but that we cannot determine exactly what that is because of the ambiguity associated with the sampling process. The situation is shown in Figure 27 where it can be seen that the electron is always following one of an infinite number of possible trajectories (of which only the first four are shown), sometimes referred to as aliases, appropriate to its energy level, but we do not know which one it is following. We cannot increase the sampling frequency because it is dictated by the way in which the orbital path length can be observed and so it is meaningless to try to relate the distance travelled to the time taken except over a complete orbital period of the lowest orbital frequency, the base energy state.

The density of these infinite number of trajectories is such that the entire space is covered by such possible trajectories and it is this that has led to the idea that the electron can be everywhere at the same time. Here we see that it cannot, it is constrained to lie on one of these infinite number of possible trajectories. While there are an infinite number of such trajectories, they do not represent all of the space, in much the same way as the infinite number of integers does not represent all of the possible numbers within a space or domain.

This gives us a slightly different view of the state of quantum indeterminacy or superposition. Here superposition is when the electron is in this state of it not being known which trajectory is being followed rather than it being everywhere. When subject to an observing process there are no structural changes to the electron; instead it is the properties of the electron, such as speed, spin etc., that are affected by the observing process due to the observer effect but the electron itself remains unaltered. The changes that take place are to the properties of the electron and to the state of knowledge of the

observer, not to the electron itself. Hence the so called measurement problem does not really exist as such.

Hence the measurement problem simply does not arise because the position of the electron is localized. In other words it always has a position which is deterministic, but not determinable. There is no such thing as the indescribable wave front. The electron exists without the need for an ether. The wavelike properties of electron derive directly from its orbital motion. There is no such process as 'collapsing', instead it is our knowledge of the state of the electron that crystalizes. The electron is always localized at a single point in space; rather it is our inability to determine the properties of the electron, its speed, spin, position etc. which underline uncertainty.

The Fine Structure Constant

Niels Bohr was able to solve his equations to match the energy levels of the Rydberg formula and as a consequence was able to derive an analytic formula for the Rydberg constant. When Sommerfeld linked the Bohr velocity to the speed of light he opened the door to allow the Fine Structure Constant to be expressed in terms of other known physical values, but the reason why it should have that particular value remained a mystery.

From the foregoing it is evident that the Fine Structure Constant (Alpha) is the value by which Gamma must be scaled in order to reduce the effective orbital path length and in turn the effective orbital velocity to a point where the forces acting on the electron are in balance. This scaling is brought about by relativity as the actual orbital velocity approaches the speed of light.

The foreshortened orbital path length and the orbital period exist in two different reference frames and can only therefore be related to one another once per orbit. We can in some sense think of this as a third reference frame, one which exists in the hinterland between that of the electron and the nucleus, one in which the orbital path length is foreshortened by relativity but the time is not dilated. This causes the velocity term to take on a series of aliases and these each result in an effective orbital velocity that results in a stable atom. Each of these stable states corresponds to a value of Gamma which is an integer multiple of the reciprocal of the Fine Structure Constant.

This constant is a recurring theme throughout atomic and nuclear physics and yet it until now it has remained one of the great unsolved mysteries of physics. Richard P Feynman said of the Fine Structure Constant:

"It has been a mystery ever since it was discovered more than fifty years ago, and all good theoretical physicists put this number up on their wall and worry about it. Immediately you would like to know where this number for a coupling comes from: is it related to pi or perhaps to the base of natural logarithms? Nobody knows. It's one of the greatest damn mysteries of physics: a magic number that comes to us with no understanding by man. You might say the "hand of God" wrote that number, and "we don't know how He pushed his pencil." We know what kind of a dance to do experimentally to measure this number very accurately, but we don't know what kind of dance to do on the computer to make this number come out, without putting it in secretly!"^{viii}

It is frequently described as *Coupling Constant*, an appropriate epithet in the light of what we have discussed, since it couples a measurement of distance in the reference frame of the moving electron with that of time measured in the reference frame of a stationary observer.

There is nothing mysterious or special about the fact that the Fine Structure Constant is a pure number, lacking units or dimensions. It simply means that it derives from the ratio of two values which have the same dimensions, in much the same way as π is dimensionless because it is the ratio of two lengths.

The introduction of Relativistic Velocity solves the mystery and shows that it is indeed the ratio of two quantities. We can think of it as the ratio of two lengths, although it is equally valid to describe it as a ratio of two times or even two masses. In terms of length, it is the ratio of the orbital circumference measured by a stationary observer to that measured by the moving electron in the hydrogen atom in its base energy state. It also occurs in each stable energy state as one of the multivalued orbital circumferences that occur due to the phenomenon of aliasing.

We can also think of Alpha as being the ratio of two times, the period of the orbit as seen by the stationary observer and the period as seen by the moving electron in the base energy state. Similarly we can view it as being two frequencies, the orbital frequency as seen by the stationary observer to that seen by the moving electron in the base energy state.

Zero Point Energy

The model also provides an explanation for the hitherto mysterious Zero Point Energy. Debate has raged about the existence and the nature of zero point energy since the concept was first introduced by Planck in 1911. With at least one interpretation showing that the atom is possessed of energy even when it is cooled to absolute zero. When an atom is cooled to absolute zero it ceases to have Brownian motion and therefore has zero kinetic energy. However the orbiting electron still has kinetic energy. The electron is orbiting at close to the speed of light and so has energy equal to $1/2mc^2$ exactly in line with prediction.

The Morphology of the Atom

The model for the atom presented here has an orbital radius which is constant for all energy states. The orbital velocity varies between 99.9973376% of the speed of light and a theoretical upper limit of the speed of light which means that atoms of different energy levels have the same overall shape and are almost indistinguishable from one another in shape and form. This is consistent with an atom whose physical and chemical properties are the same in all energy states, which is what we find in practice.

Planck's constant

Bohr's model for the atom was based on the idea that Planck's constant was the fundamental unit of angular momentum and that each energy level was associated with a integer multiple of this basic unit. That assumption was carried over into all subsequent models within quantum theory. The assumption has been shown to be false. Angular momentum is not quantized; instead we find that it is the Lorentz factor, Gamma, which is quantized. Here Planck's constant is still seen as the orbital angular momentum of the electron, but rather than being quantized, it is constrained by the dynamics of the atom to have a particular value for all energy states.

But why exactly is Planck's constant; constant at all? Why is the angular momentum forced to take in this particular value?

Planck's constant is a measure of the orbital angular momentum of the electron orbiting the hydrogen nucleus. It is the product of three variables, the mass of the electron, its tangential velocity and its orbital radius.

If angular momentum were to be quantized it would require a complex interplay between these three variables plus that of the energy level of the atom such that when the velocity changes so too does the orbital radius and vice versa. The velocity must somehow be cognizant of the change in the orbital radius so as to comply with the quantization requirement or the radius must cognizant of the change in the velocity. The problem with this is that there is no mechanism which could cause this to happen. There is no causal link between changes in orbital radius and orbital velocity. The only link is that they must do this to comply with the quantization requirement, which is rather like saying it is quantized because it is quantized. Or as St Anselm put it – God exists because God exists.

The idea that Planck's constant is equal to the orbital angular momentum of the electron is not unreasonable since it has the units of angular momentum. Only now let's consider what happens when orbital velocity is seen as being affected by relativity.

$$\hbar = m\gamma R \frac{c}{\gamma} \quad \text{Equation 98}$$

Equation 98 is that for the orbital angular momentum as seen from the point of view of a stationary observer located at the atomic nucleus. For such an observer the electron is moving at near light speed and so both its mass and its velocity are affected by relativity but in the opposite sense. The equation links Planck's constant to the orbital radius, the mass and the velocity of the orbiting electron, but it also includes the factor Gamma, only here it occurs twice, once in the numerator, where it acts to modify the rest mass of the moving electron in line with relativity, and once in the denominator where it acts to modify the orbital speed to create the Relativistic Velocity term.

A closer examination of the terms of the equation reveals that the rest mass of the electron is constant and the speed of light is constant. The orbital radius is measured at right angles to the direction of travel of the electron and is therefore unaffected by relativity and so remains constant. The result is that Planck's constant, which is a measure of the angular momentum of the electron, is invariant with respect to orbital velocity and so must be constant.

The mass term and the velocity term are both affected by relativity, but in the opposite sense to one another. The mass increases by the factor Gamma, while at the same time the velocity is reduced by the same factor Gamma. The result is that the angular momentum remains the same. The important point to note here is that there is no complex interaction between these two variables. Each one separately, independently and blindly obeys the laws of special relativity and the result combines to cancel out, leaving the angular momentum unchanged as the orbital velocity varies.

If we now view the angular momentum from within the reference frame of the electron, the electron is possessed of its rest mass and its orbital velocity is near light speed, which in this context is seen as being invariant with respect to relativity. The radius is the same as for the stationary observer and so the orbital angular momentum is given by the formula

$$\hbar = mRc \quad \text{Equation 99}$$

Hence there is a not only an invariance for Planck's constant within the domain of the stationary observer but also an invariance between the value for Planck's constant between this domain and that of the moving observer.

Strictly speaking then Planck's constant is not a constant at all, it is invariant with respect to velocity close to the speed of light and it is invariant between the reference frames of the stationary and moving observers.

All of the three factors which make up angular momentum are continuous variables and so in general angular momentum is itself a continuous variable. However in the context of the atom it is coerced into taking on a particular discrete value by virtue of the effects of relativity.

As the orbital velocity increases, so does the value of Gamma. This causes the effective mass of the electron to increase, but at the same time the orbital path length, and therefore the Relativistic Velocity decreases in the same measure. We can think of this rather like a mathematical see-saw, as one goes up the other goes down, with Planck's constant at the fulcrum between these two. The two Gamma terms balance one another out but at the same time they force the angular momentum of the orbiting electron to maintain its constant value. One cannot alter without the other altering and the sensitivity to any such change increases with Gamma. The higher the value of Gamma, the more

tightly the angular momentum is constrained to be a constant value. Since the rest mass and the speed of light are both constants, this means that the orbital radius is also constrained to have a fixed value. As to angular momentum itself, it is not quantized but is continuous and, in general, is capable of taking on any value. However the effects of relativity combined with an orbital velocity near light speed constrain it to have a particular value in the context of the atom.

Duality, Waves and Particles

Special relativity is unique among physical phenomena in seemingly providing two answers to the same question, a sort of natural duality. So for example there are two distances between points in space, one measured by a stationary observer and one by a moving observer, equally there are two time intervals and, where cyclic behaviour is observed there are two frequencies and two wavelengths. Special relativity addresses the problem of dual solutions outlined by de Broglie directly and would therefore seem to be a natural place to start when looking for any form of duality.

In any reference frame we can imagine a set of measurements such as distance, time, mass etc. which are those experienced by a stationary observer. For an object which is moving with respect to that reference frame those same measurements have different values which are related to the first through relativity. Distance is foreshortened; time is dilated and mass is increased. For objects which are moving relatively slowly these two sets of measurements are very similar. At higher speeds these two sets of measurements begin to diverge quite markedly. A particularly significant point of divergence occurs when the speed is such that the Lorentz factor, Gamma, has a value of 137.036 or a multiple thereof. This particular speed is associated with the stable orbits of electrons within the hydrogen atom. For objects in orbit certain of these measurements take on multiple values all of which are valid at the same time and it is this that leads to the discrete energy levels that are found within the atom.

In all of this the wave characteristics of the electron derive directly from its orbital motion. The wave is an attribute of the particle, brought about by its motion rather than something which is integral to the particle. Whether it is viewed from the perspective of the stationary observer or from that of the moving electron, the relationship between the wavelength, frequency and velocity is consistent with classical theory within its respective reference frame. Wavelength is related to the orbital angular momentum divided by the linear angular momentum. For the stationary observer the orbital velocity is to all intents and purposes equal to the speed of light and the radius is \hbar/mc and so its angular frequency is more or less constant at mc^2/\hbar . For the moving electron the orbital velocity is its Relativistic Velocity in the n^{th} stable state and the radius is the same as that of the stationary observer. The orbital frequency is $nmc^2/\hbar\alpha$ and thus forms a harmonic series.

It is more sensible therefore to speak of a wave/particle identity in which frequency, wavelength, amplitude and phase are all related within their respective reference frames with orbital radius, circumference and period in this conventional way. The duality exists between the two reference frames, hence there are two frequencies, one in the reference frame of the electron and one in the reference frame of the stationary observer and there are two orbital path lengths, one in the reference frame of the electron and one in the reference frame of the stationary observer. And, it is argued here, there are two velocities. It is better to describe this as a wave duality and a separate but related particle duality.

The Laws of Dynamics

All of the above implies that the laws of dynamics as we currently understand them are incorrect and will need to be modified. We know already that this is the case because Newtonian dynamics fails to account for the discrete energy levels of the atom. The only question is what form that modification should take. The pioneers of quantum theory assumed that the necessary modification was that angular momentum could only take on discrete values which were an integer multiple of Planck's

constant. However this leads directly to the physically impossible quantum leap and indirectly to numerous incomprehensible phenomena and so cannot be true.

The integer ‘n’

Symbols and letters are often used to denote mathematical entities; the letter ‘x’ is commonly used as the independent variable while ‘y’ is the dependent variable. The letter ‘t’ represents time and when we run out of letters in the Latin alphabet we can always resort to the Greek one for a whole new set of symbols for example ‘ π ’ or ‘ θ ’ to represent an angle. All of which brings us in a roundabout way to the letter ‘n’. ‘n’ is used to denote an integer, a whole number. Where more than one integer is required we can use ‘n’s near neighbour ‘m’, but this could be confused with ‘m’ for mass, so commonly we would add a suffix to ‘n’ to give us ‘n₁’, ‘n₂’ etc. as with the Rydberg formula earlier.

Put simply the problem facing Bohr and the pioneers of quantum theory was to discover a means by which to include such a multiplier in the equations that describe the dynamics of the atom. The solution they chose was to simply and arbitrarily associated it with angular momentum. It seemed to work, at least in so far as it returned energy levels that matched those of the Rydberg formula. Closer examination however reveals that it is not the Bohr model, nor indeed that of de Broglie or Schrödinger or any of the models that use Nicholson’s assumption that leads to this result, but the presence of the integer multiplier ‘n’ that leads to this success.

This applies, not just to the energy levels of the atom, but a number of values that spring from this calculation. Values such as the Sommerfeld Fine Structure Constant, the Bohr radius and Bohr velocity, the Compton wavelength and even Planck’s constant itself, form the building blocks of quantum mechanics. There is nothing about the derivation of these values that requires specifically that angular momentum is quantized. It is the presence of the factor n that leads to these building blocks and their numerical values that is ultimately responsible for the accuracy of quantum mechanics and not the structure of the model from which they derive.

Unification of Quantum and Classical Dynamics

The unification of observable phenomena into one overarching law is one of the primary goals of physics. In the 17th century Newton unified gravity with astronomy by formulating the inverse square law, while in the 19th century Maxwell and Lorentz between them unified electricity and magnetism into a single electro-magnetic force and Clausius together with Maxwell unified heat with mechanical energy with the kinetic theory of gases.

The lesson from St Anselm is that any attempt to validate quantum theory must begin by accepting that there must be an as yet undiscovered modification to Newtonian mechanics. That is true not just for the existing model but must be true for any new model and it is certainly true for the model proposed here.

The key to the unification of quantum and classical dynamics is to understand how velocity is the relationship between distance and time each measured in different reference frames and that distance can only be meaningfully established over one or more complete orbits. This leads to the idea of a velocity term which straddles the two domains and forces us into a situation where distance and time can only be related to one another at certain discrete times. The combined effects of this sampling process and of special relativity create a mechanism that causes the electron to only be able to orbit at certain discrete energy levels.

Relativistic Velocity asserts that certain orbital velocity terms are affected by relativity and comes about because these terms are composed of the orbital path length foreshortened by relativity divided by the orbital period which is unaffected by relativity. One constraint on the existence of such a velocity term is that the orbital path length can only be measured or experienced over a whole orbit or

whole number of orbits. This in turn introduces a sampling process whereby the orbital circumference is sampled in time with a sampled frequency equal to the orbital period. The consequence of this sampling is to create aliases for the orbital path length which in turn creates aliases for the orbital velocity and centrifugal force.

It is the idea that as the actual velocity increases, the effective velocity reduces, which leads to the stable states of the atom. The first stable state occurs when the effective orbital velocity is scaled down due to relativity by a when Gamma has a value of 137.036 and subsequent stable states correspond to values of Gamma which are an integer multiple of this base value.

The fact that Gamma appears in the denominator of the term for the centrifugal force acting on the electron means that any deviation from its prescribed orbit is opposed by a massive force relative to any other forces acting on the electron and so relativity causes the electron to orbit the atom without the emission of synchrotron radiation.

All of this takes place in the classical domain using a set of equations that would be recognizable to Newton, as modified by Einstein to take account of special relativity. There is just one simple and plausible extension regarding the nature of velocity and that is to assert when considering objects in orbit such orbital velocity is affected by relativity. The causal relationship between the realms of classical mechanics and quantum mechanics is thus a series of links, a chain of causality which effectively unifies the quantum and classical domains.

Appendix 1 Proof of Aliasing

The proof of aliasing was first carried out by Claude Shannon in 1949^{ix}. Versions of this proof can be found in most standard texts on digital signal processing.

Aliasing is the name given to the phenomenon where two distinct signals $x_1(t)$ and $x_2(t)$ give the same set of values $x[n]$ when sampled at a fixed rate f_s . We shall consider the case where x_1 and x_2 are both sinusoids.

$$x[n] = \cos(2\pi f \frac{n}{f_s} + \phi) \quad \text{Equation A1}$$

Two signals will be aliases of one another if they meet the condition

$$f_2 = f_1 + kf_s \quad \text{Equation A2}$$

Where f_s is the sampling frequency and k is an integer.

Sampling the two sinusoidal waves, x_1 and x_2 , at a rate of f_s will produce the following sequences

$$x_1[n] = A \cos(2\pi f_1 \frac{n}{f_s} + \phi) \quad \text{Equation A3}$$

$$x_2[n] = A \cos(2\pi f_2 \frac{n}{f_s} + \phi) \quad \text{Equation A4}$$

The signals will be aliases of one another if $x_1[n] = x_2[n]$ for all $n = 1, 2, 3, \dots$

To prove the equation we rely on the identity $\cos(\theta + 2\pi k) = \cos(\theta)$ for all integer k .

Substituting for f_2 in Equation A4

$$x_2[n] = A \cos(2\pi f_1 + 2\pi kf_s \frac{n}{f_s} + \phi) \quad \text{Equation A5}$$

$$x_2[n] = A \cos(2\pi f_1 \frac{n}{F_s} + 2\pi kn + \phi) \quad \text{Equation A6}$$

$$x_2[n] = A \cos(2\pi f_1 \frac{n}{f_s} + \phi) = x_1[n] \quad \text{Equation A7}$$

Here we are dealing with the special case where $F_s = F_1$ and so

$$x_1[n] = x_2[n] = A \cos(\phi) \quad \text{Equation A8}$$

And

$$f_2 = nf_1 \quad \text{Equation A9}$$

In other words the orbital frequencies form a harmonic series with base frequency F_1 .

Appendix 2 Constants and Formulae

Constant	Symbol	Value	Units
Gravitational constant	G	6.6743×10^{-11}	$\text{m}^3 \text{kg}^{-1} \text{s}^{-2}$
Electrical constant	K	8.9875517923×10^9	$\frac{\text{Kg m}^3 \text{s}^{-2}}{\text{C}^{-2}}$
Charge on electron	q	$1.60217663 \times 10^{-19}$	C
Mass of Electron	m	$9.1093837015 \times 10^{-31}$	Kg
Mass of the proton	m_p	1.67262×10^{-27}	Kg
Planck's constant	h	$6.62607015 \times 10^{-34}$	J s
Planck's constant	\hbar	$1.054571817... \times 10^{-34}$	J s
Planck's constant	h	4.14E-15	eV s
Planck's constant	\hbar	$6.582119569... \times 10^{-16}$	eV s
Joules to eV	J-eV	$6.241 509 074... \times 10^{18}$	eV/J
Speed of light	c	299792458	m/s
Reduced Compton Wavelength	R	3.86159×10^{-13}	m
Fine Structure Constant	α $1/\alpha$	0.007297728 137.036	
Bohr velocity		2187803	m/s
Rydberg constant	R_H	10973731.568160	m^{-1}
Linear momentum	l	mv	Kg m s^{-1}
Angular momentum	L	mvr	$\text{kg m}^2 \text{s}^{-1}$
Moment of inertia of body in orbit	I	mr^2	kg m^2
Kinetic energy	E	$\frac{1}{2}mv^2$	J
Kinetic energy	E	$\frac{1}{2}I\omega^2$	J
Electrostatic force	f	$\frac{Kq_1q_2}{d^2}$	N
Inertial force	f	ma	N
Lorentz factor	γ	$\frac{c^2}{\sqrt{c^2 - v^2}}$	

Reduced Compton Wavelength	R	$\frac{\hbar}{mc}$	m
Fine Structure Constant	α	$\frac{Kq^2}{\hbar c}$	
Planck's equation	E	$\hbar\omega$	J

ⁱ Louis de Broglie – *Biographical*. *NobelPrize.org*. Nobel Prize Outreach AB 2023.
<https://www.nobelprize.org/prizes/physics/1929/broglie/biographical/>

ⁱⁱ De Broglie, Louis, *Une Tentative D'Interpretation Causale et Non Lineaire De La Mecanique Ondulatoire - (La Theorie De La Double Solution)*
Published by Gauthier-Villars, 1956

ⁱⁱⁱ H. Nyquist, *Certain Topics in Telegraph Transmission Theory*, Trans. AIEE, vol 47, pp 617-644, Apr 1928

^{iv} C. E Shannon, *Communication in the Presence of Noise*, Proc. Institute of Radio Engineers, vol 37 no. 1 pp 10-21, Jan 1949.

^v Bracewell, R.N. (1986), *The Fourier Transform and Its Applications (revised ed.)*, McGraw-Hill; 1st ed. 1965, 2nd ed. 1978

^{vi} Joseph K Blitzstein, Jessica Hwang, *Introduction to Probability, Second Edition*, pp 458-459, Chapman& Hall, 2019 ISBN 13: 9781138369917

^{vii} Knopp, K. *Theory of Functions Parts I and II, Two Volumes Bound as One*. New York: Dover, Part I p. 103 and Part II p. 93, 1996.

^{ix} Shannon, Claude E. (January 1949). "Communication in the presence of noise". Proceedings of the Institute of Radio Engineers. **37** (1): 10–21.